



INSTALLATION GUIDE

2022-UP/TOYOTA TUNDRA STEALTH CENTER MOUNT FRONT BUMPER F760343070103



TOOLS REQUIRED

- (Allen) 5/32, 7/32, 5/16
- (Wrench) 10mm, 17mm, 7/16, 9/16, 3/4
- (Socket) 10mm, 17mm, 7/16, 9/16, 3/4
- Jigsaw
- Ratchet
- Flat Head/Fastener Remover



TIME REQUIRED

- 2.5 hours for OEM Removal/Bumper Install
- 1 Additional Hour to Wire Lights

****Labor Rates are based on a vehicle with no pre-existing damage. Wiring labor is based on a standard wiring procedure with light switches installed in an easily accessible location. Custom light triggering or switch mounting location will result in a greater labor charge.****



SKILL LEVEL



Medium

****This installation requires 2 people for best results****

⚠️ WARNINGS/CAUTIONS BEFORE STARTING INSTALLATION ⚠️

-BEFORE YOU INSTALL THIS KIT-

Read and understand all instructions, warnings, cautions, & notes contained in this installation instruction guide. Consult your vehicle owner's manual for proper disconnection of electrical and lifting of vehicle if required for installation of this product.

This install may require some technical skills and knowledge of basic mechanical work. If you do not feel that you are capable of performing this install please take this product to a trained professional.

After reading this guide please contact us with any questions or concerns before installing product.

Customer Service (480) 671-0820
Addictive desert designs is not responsible for any bodily injury or harm to you or your vehicle as a result of an improper install.

Proper installation of this kit required knowledge of the factory recommended procedures for removal and installation of original equipment components.

We recommend that the factory shop manual and any special tools needed to service your vehicle be on hand during the installation. Installation of this kit without proper knowledge of the factory recommended procedures may affect the performance of these

components and the safety of the vehicle. Inspect all contents of this package to make sure product is not damaged and all installation hardware has been included. If parts are missing from kit, please be prepared to provide the following information:

1. Name of purchase location
2. Bar Code on side of box
3. Date above bar code
4. Date inside box cover

ALWAYS WEAR EYE PROTECTION WHEN OPERATING POWER TOOLS



INSTALLATION GUIDE

HARDWARE

A.



1/4-20 X 3/4" BUTTON HEAD BOLT

QTY: 8

A1.



1/4" FLAT WASHER

QTY: 8

A2.



1/4-20" NYLON LOCK NUT

QTY: 8

B.



3/8-16 X 1" BUTTON HEAD BOLT BLACK

QTY: 17

B1.



3/8-16 NYLON LOCK NUT BLACK

QTY: 17

B2.



3/8 FLAT WASHER BLACK

QTY: 19

C.



3/8-16 X 1" HEX HEAD BOLT YELLOW

QTY: 4

C1.



3/8-16" NYLON LOCK NUT YELLOW

QTY: 4

C2.



3/8" FLAT WASHER YELLOW

QTY: 8

D.

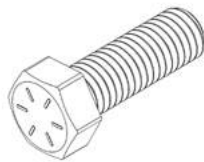

1/2-13 X 1 1/2" HEX HEAD BOLT YELLOW

QTY: 14

D1.



1/2 FLAT WASHER YELLOW

QTY: 28

D2.

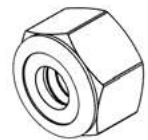

1/2-13 NYLON LOCK NUT YELLOW

QTY: 14

E.



1/2-13 X 1 1/2" BUTTON HEAD BOLT

QTY: 2

E1.

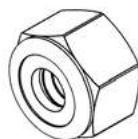

1/2-13" NYLON LOCK NUT

QTY: 2

E2.



1/2 FLAT WASHER

QTY: 2

F.





3M DOUBLE SIDED TAPE

QTY: 4

HARDWARE

SENSOR GROMMETS SUPPLIED FOR NON SENSOR TRIMS



3/4" RUBBER SENSOR GROMMET
QTY: 4

3/4" PLASTIC SENSOR GROMMET PLUG
QTY: 4

PARTS

G.

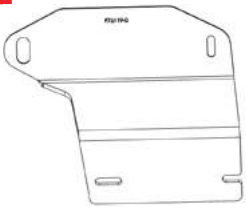

SSF1008B

QTY: 1

H.



SSF1009

QTY: 1

I.



SSF1010

QTY: 1

J.



SSF1011

QTY: 1

K.

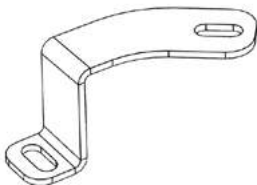

SST0410, SST0410-M

QTY: 1

L.

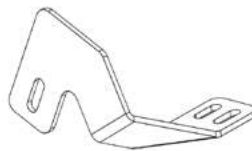

SST0401, SST0401-M

QTY: 1

M.



AST0186

QTY: 1



INSTALLATION **GUIDE**

STEALTH CENTER MOUNT FRONT BUMPER 2022-UP/TOYOTA TUNDRA

REMOVAL

□ STEP 1

Remove the 4x bolts on top of the grill using a (10mm socket).

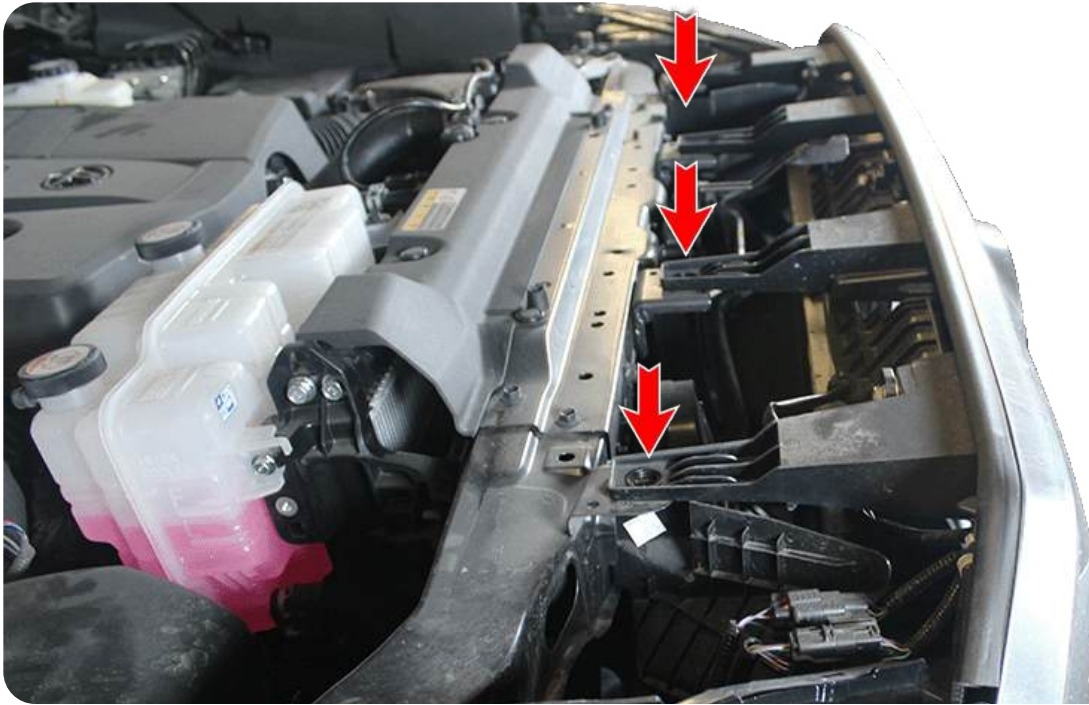



INSTALLATION GUIDE

STEALTH CENTER MOUNT FRONT BUMPER 2022-UP/TOYOTA TUNDRA

REMOVAL

□ STEP 2

Unplug the 3x wiring harness plugs.

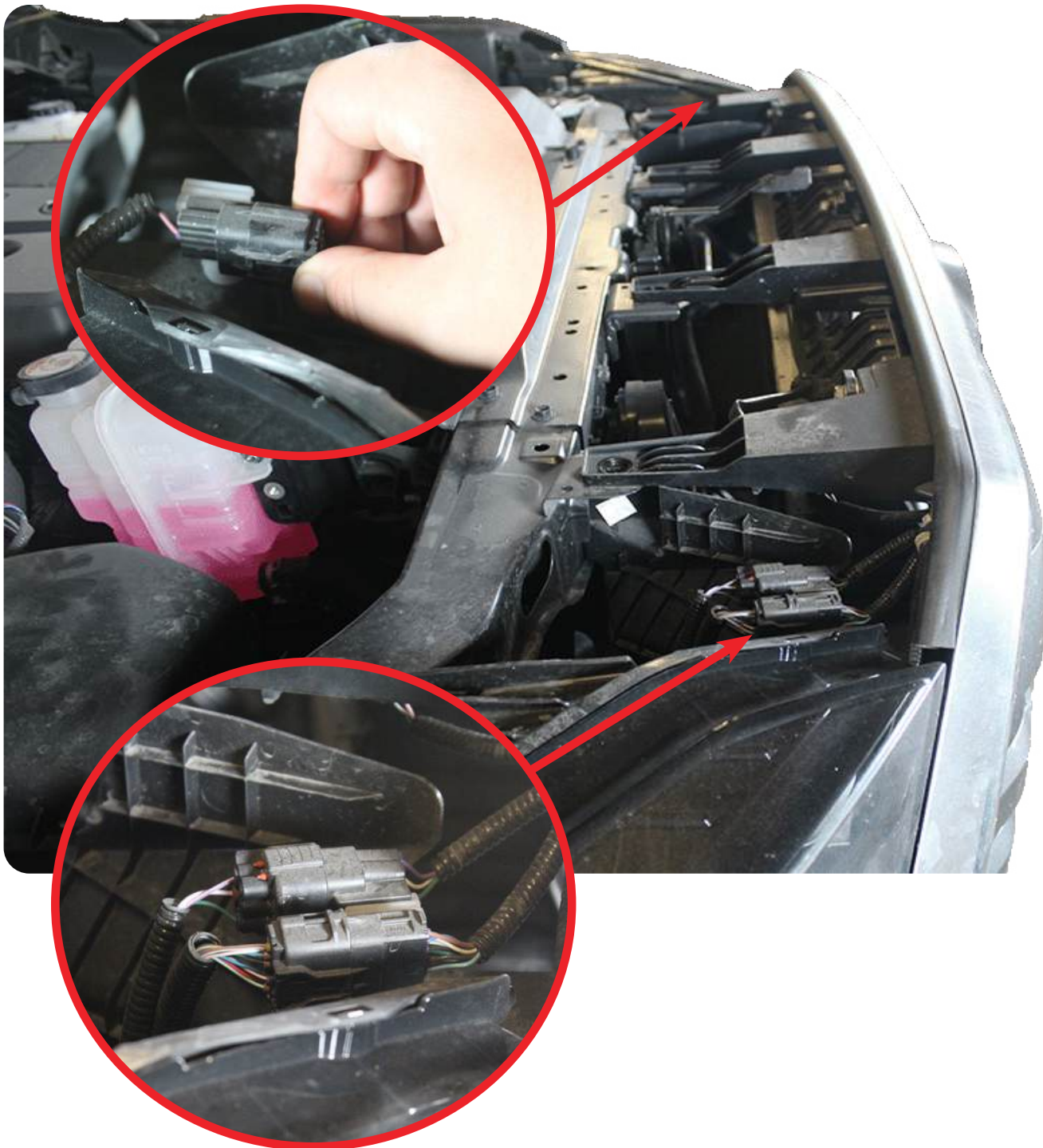



INSTALLATION **GUIDE**

STEALTH CENTER MOUNT FRONT BUMPER 2022-UP/TOYOTA TUNDRA

REMOVAL

STEP 3

Remove the 2x support mount bolts from underneath the bumper using a (10mm socket).

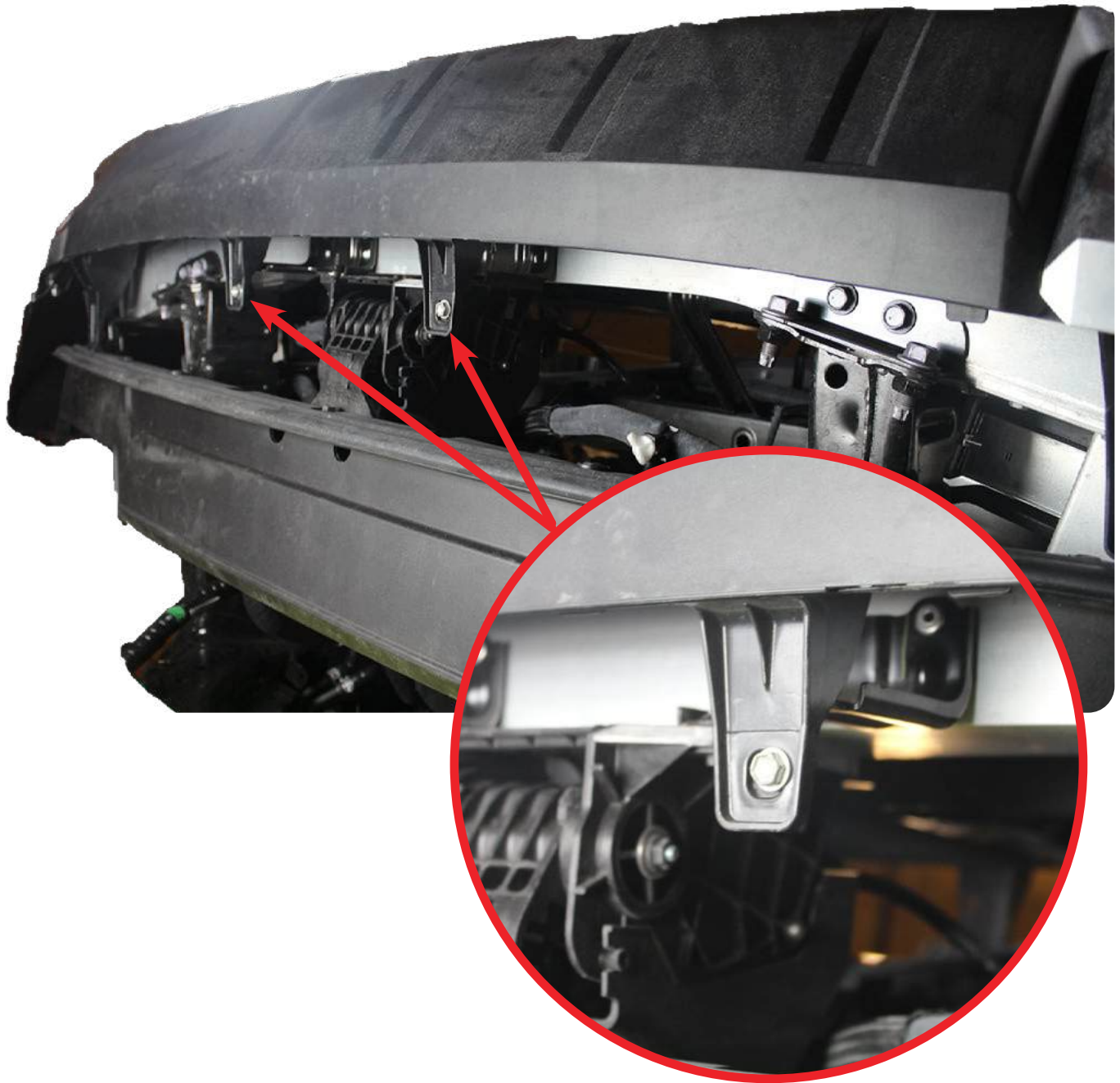

STEALTH CENTER MOUNT FRONT BUMPER 2022-UP/TOYOTA TUNDRA

REMOVAL

□ STEP 4

Inside the wheel well, remove the 4x bolts holding the trim by using a (10mm socket). After, pop both trim and grill off by pulling towards you. You can now remove the grill.

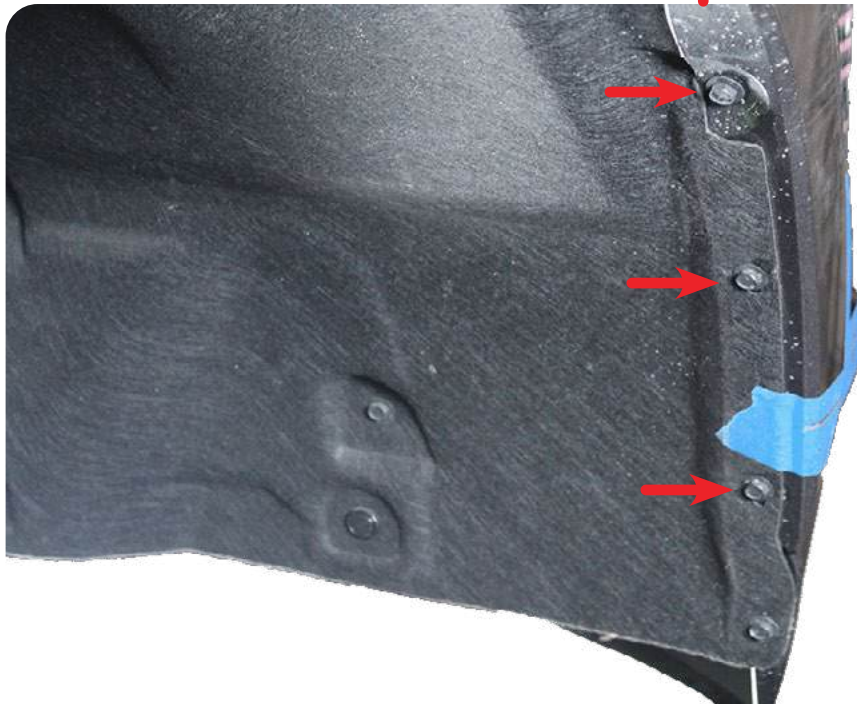



INSTALLATION **GUIDE**

STEALTH CENTER MOUNT FRONT BUMPER
2022-UP/TOYOTA TUNDRA

REMOVAL



STEALTH CENTER MOUNT FRONT BUMPER 2022-UP/TOYOTA TUNDRA

REMOVAL

□ STEP 5

Unplug the air dam motor by depressing and pulling.

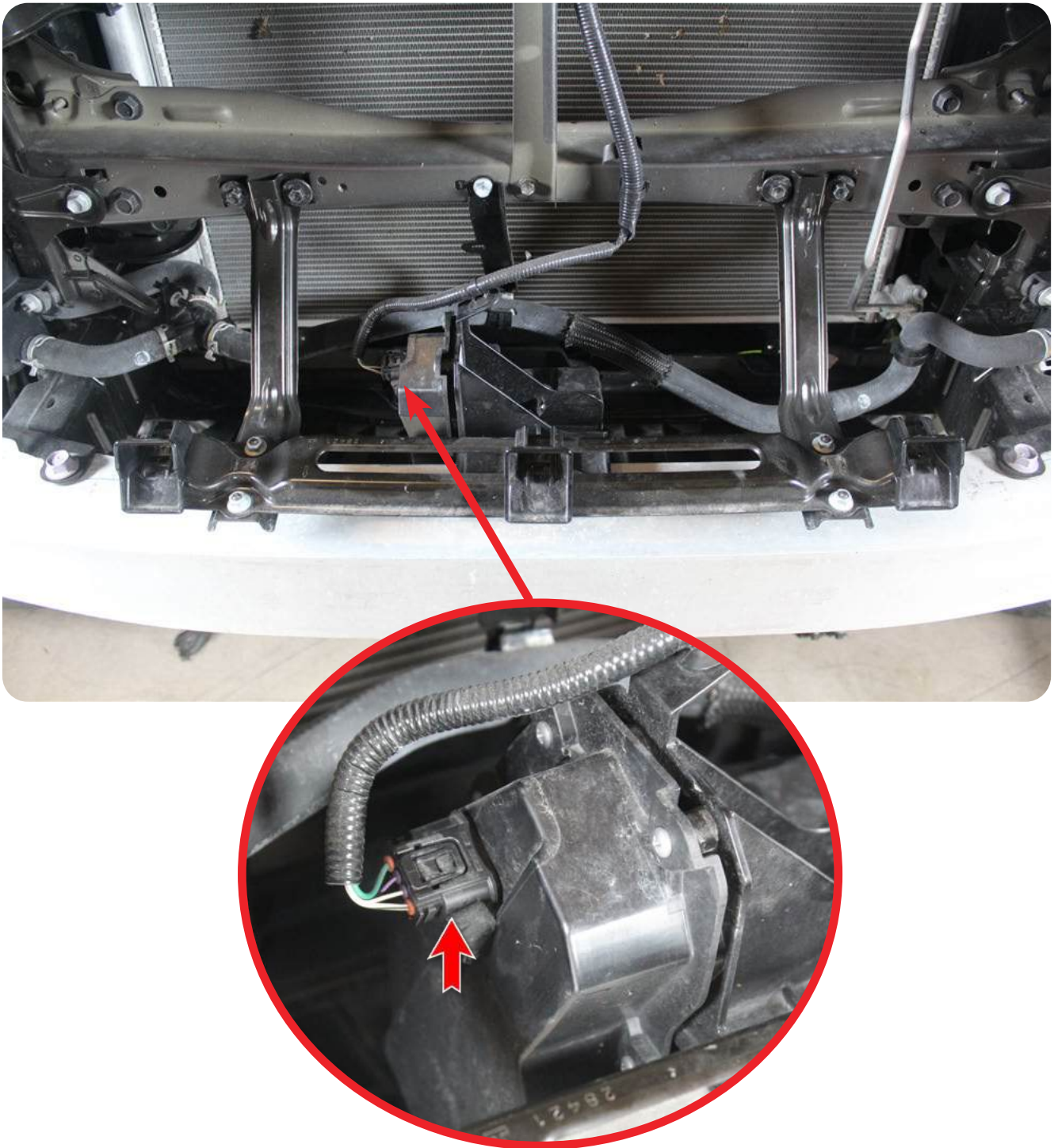

STEALTH CENTER MOUNT FRONT BUMPER 2022-UP/TOYOTA TUNDRA

REMOVAL

□ STEP 6

Remove the 4x aluminum crash bar bolts on top and bottom by using a (17mm socket).





INSTALLATION GUIDE

STEALTH CENTER MOUNT FRONT BUMPER
2022-UP/TOYOTA TUNDRA

REMOVAL



STEALTH CENTER MOUNT FRONT BUMPER 2022-UP/TOYOTA TUNDRA

REMOVAL

□ STEP 7

Remove the air dam motor by using a (10mm socket). Remove the 6x bolts shown below.

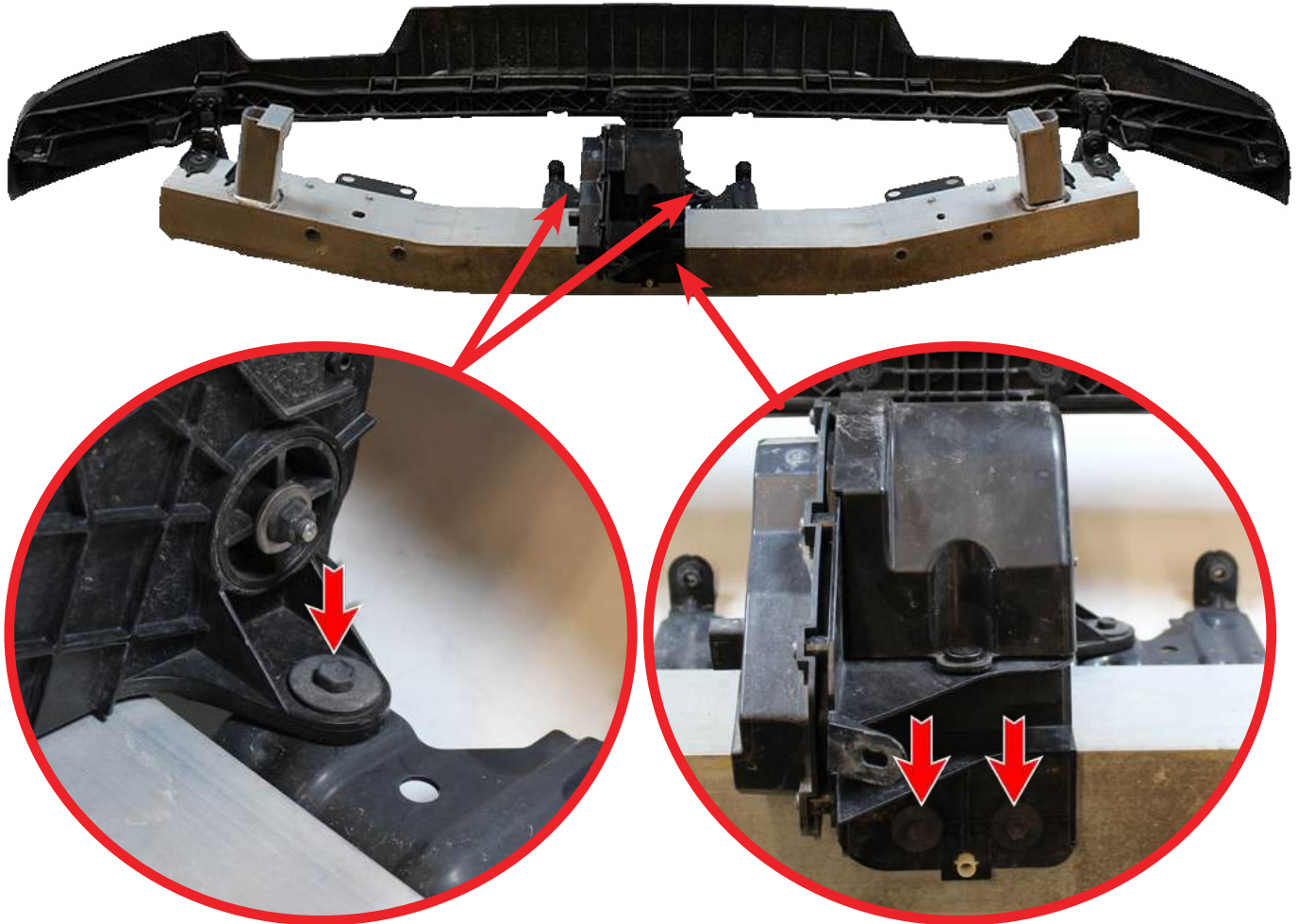

STEALTH CENTER MOUNT FRONT BUMPER 2022-UP/TOYOTA TUNDRA

REMOVAL

□ STEP 8

Flip the air dam over and remove the 2x bolts from the bottom as shown below using a (10mm socket).

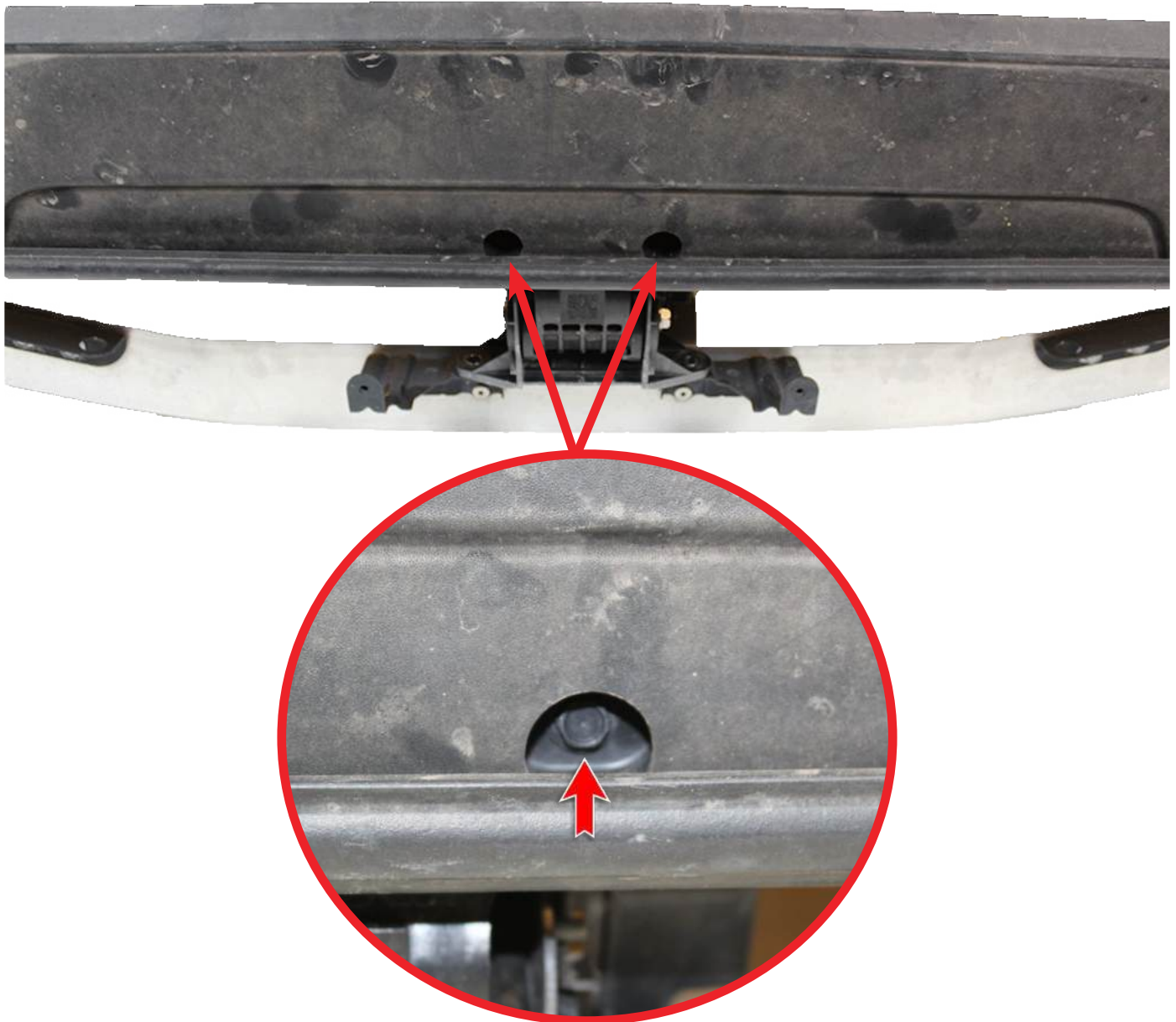

STEALTH CENTER MOUNT FRONT BUMPER 2022-UP/TOYOTA TUNDRA

REMOVAL

□ STEP 9

After the air dam motor has been removed, cut along the lines as shown below with your choice of cutting tools. ****It is important to cut on the dotted line for clearance****

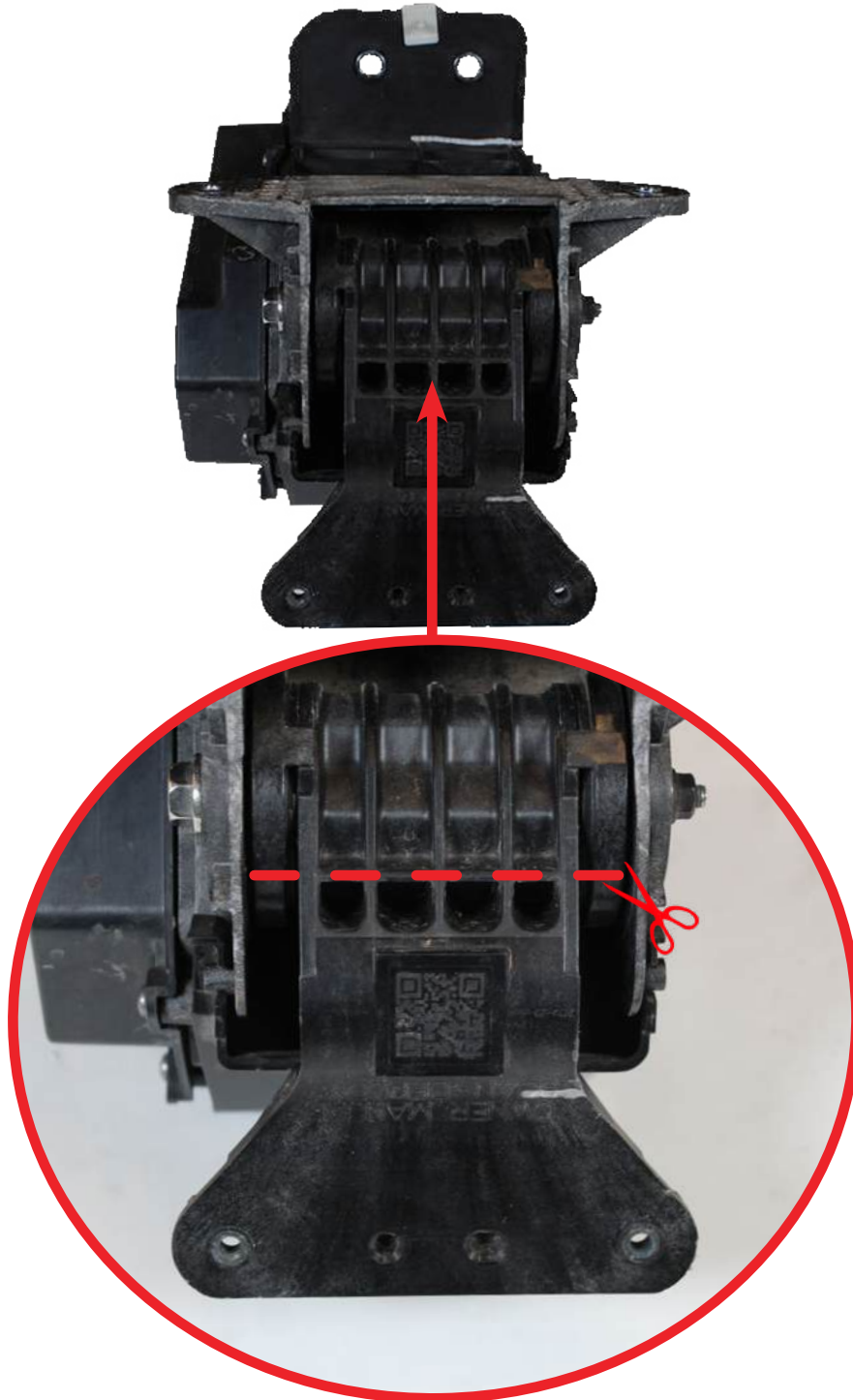



INSTALLATION **GUIDE**

STEALTH CENTER MOUNT FRONT BUMPER
2022-UP/TOYOTA TUNDRA

REMOVAL

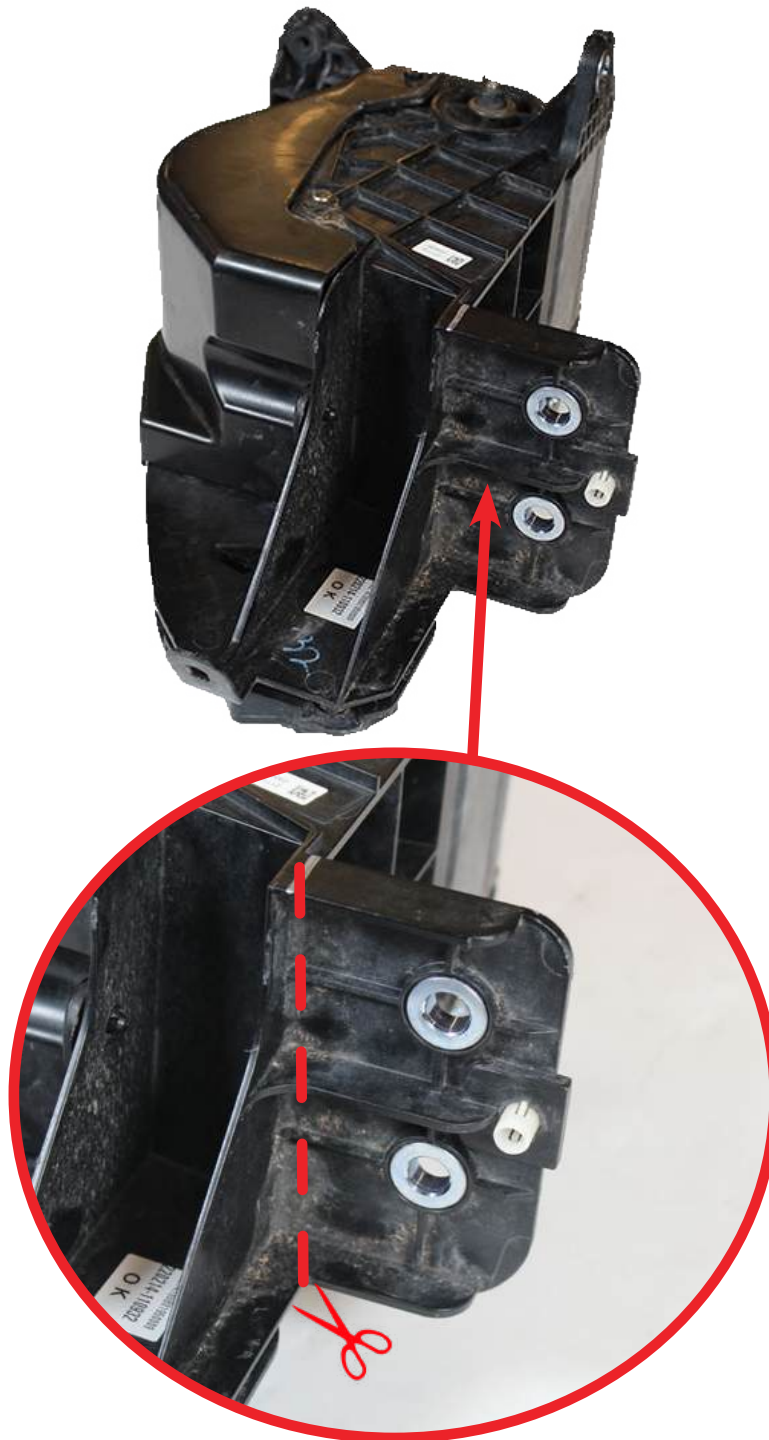

STEALTH CENTER MOUNT FRONT BUMPER 2022-UP/TOYOTA TUNDRA

REMOVAL

□ STEP 10

Remove one out of the four stock bolts shown below using a (10mm socket).

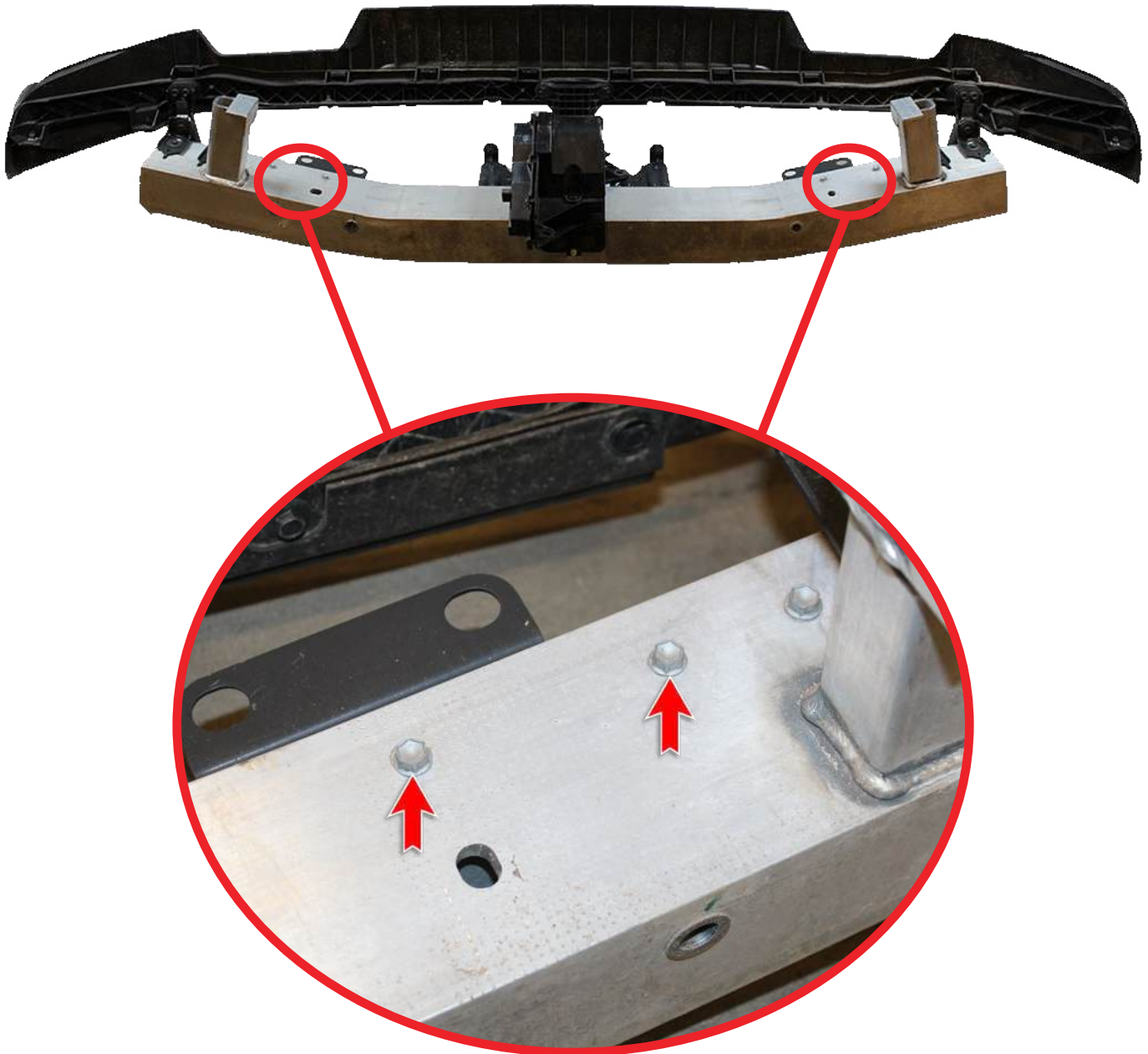

STEALTH CENTER MOUNT FRONT BUMPER 2022-UP/TOYOTA TUNDRA

INSTALL

□ STEP 11

Using the stock bolt taken from **step 11**, install the air dam motor bracket **(G)** in the existing threaded holes shown below using a (10mm socket).

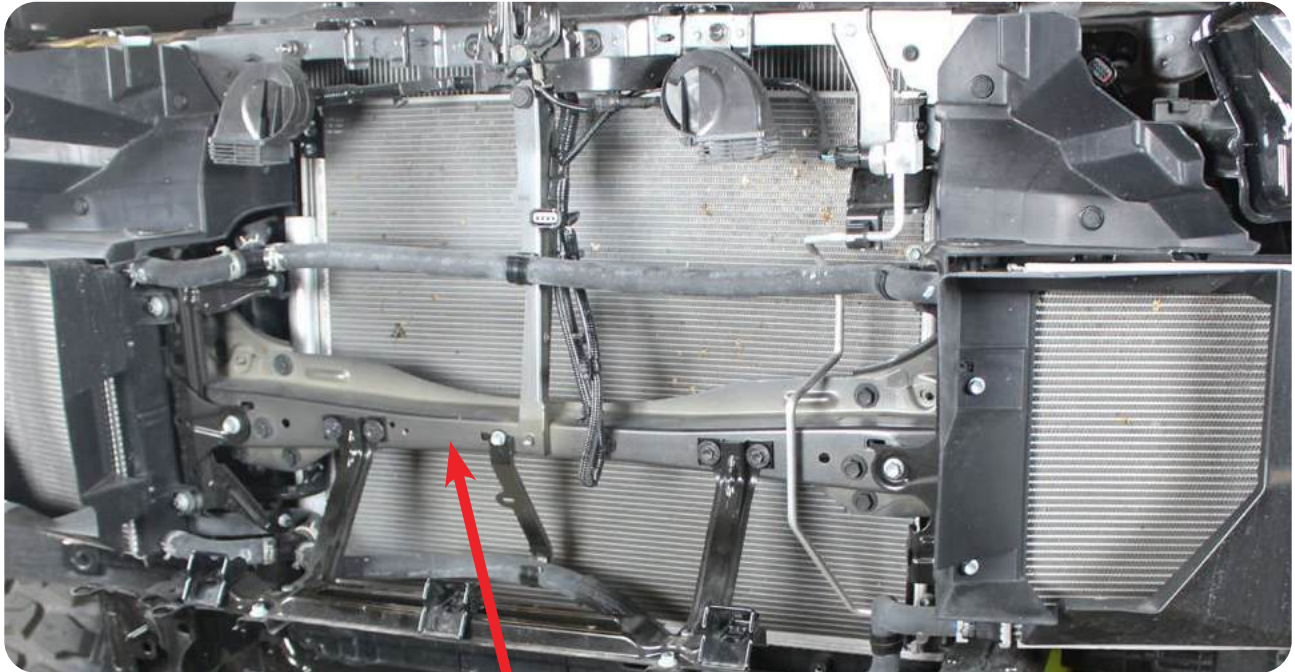

STEALTH CENTER MOUNT FRONT BUMPER 2022-UP/TOYOTA TUNDRA

INSTALL

□ STEP 12

Install the air dam motor using the provided **(H, I)** washers, and **(B, B1, B2)** 3/8" hardware using a (7/32 allen) and a (9/16 wrench). And the provided **(A, A1, A2)** 1/4" hardware using a (5/32 allen) and a (7/16 wrench).

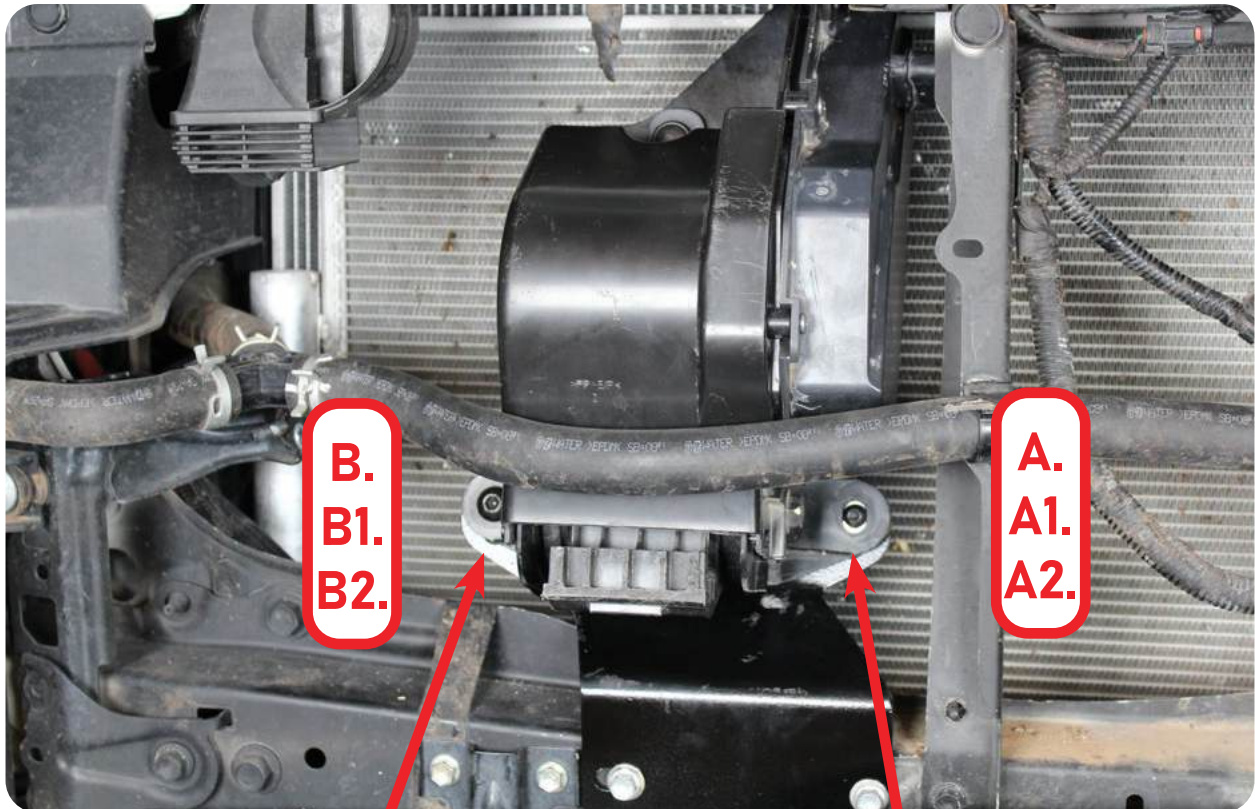



INSTALLATION GUIDE

STEALTH CENTER MOUNT FRONT BUMPER 2022-UP/TOYOTA TUNDRA

INSTALL

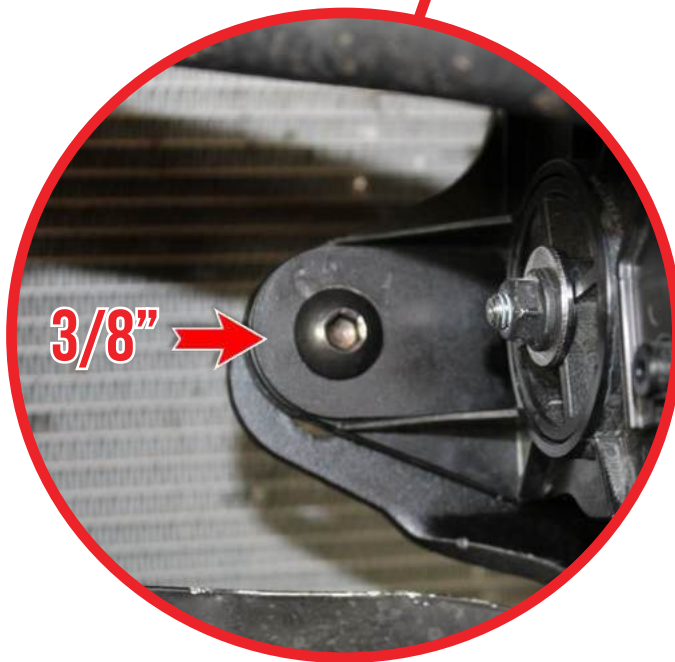
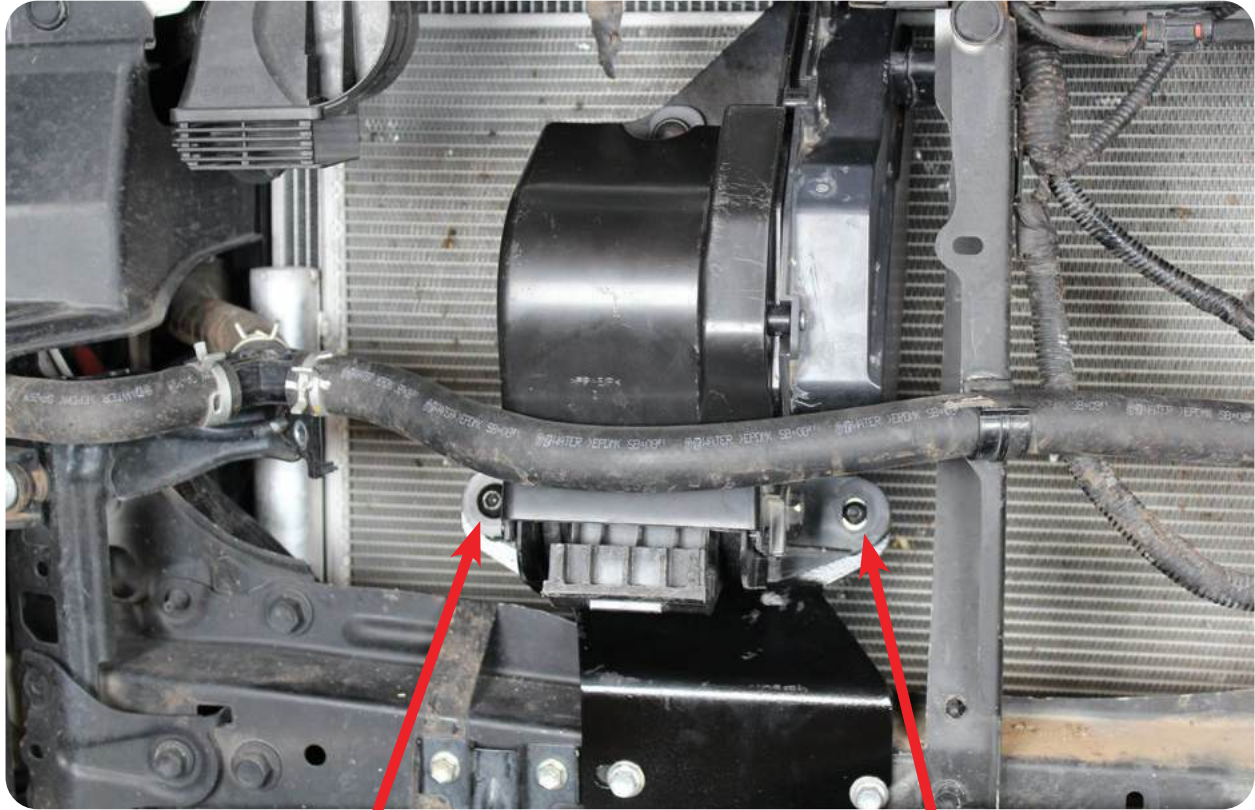

STEALTH CENTER MOUNT FRONT BUMPER 2022-UP/TOYOTA TUNDRA

INSTALL

□ STEP 13

Install the air dam motor top bracket (**J**) to the top rail and the air dam motor as shown on page 21 using the provided (**A, A1, A2**) 1/4" hardware using a (5/32 allen) and a (7/16 wrench).

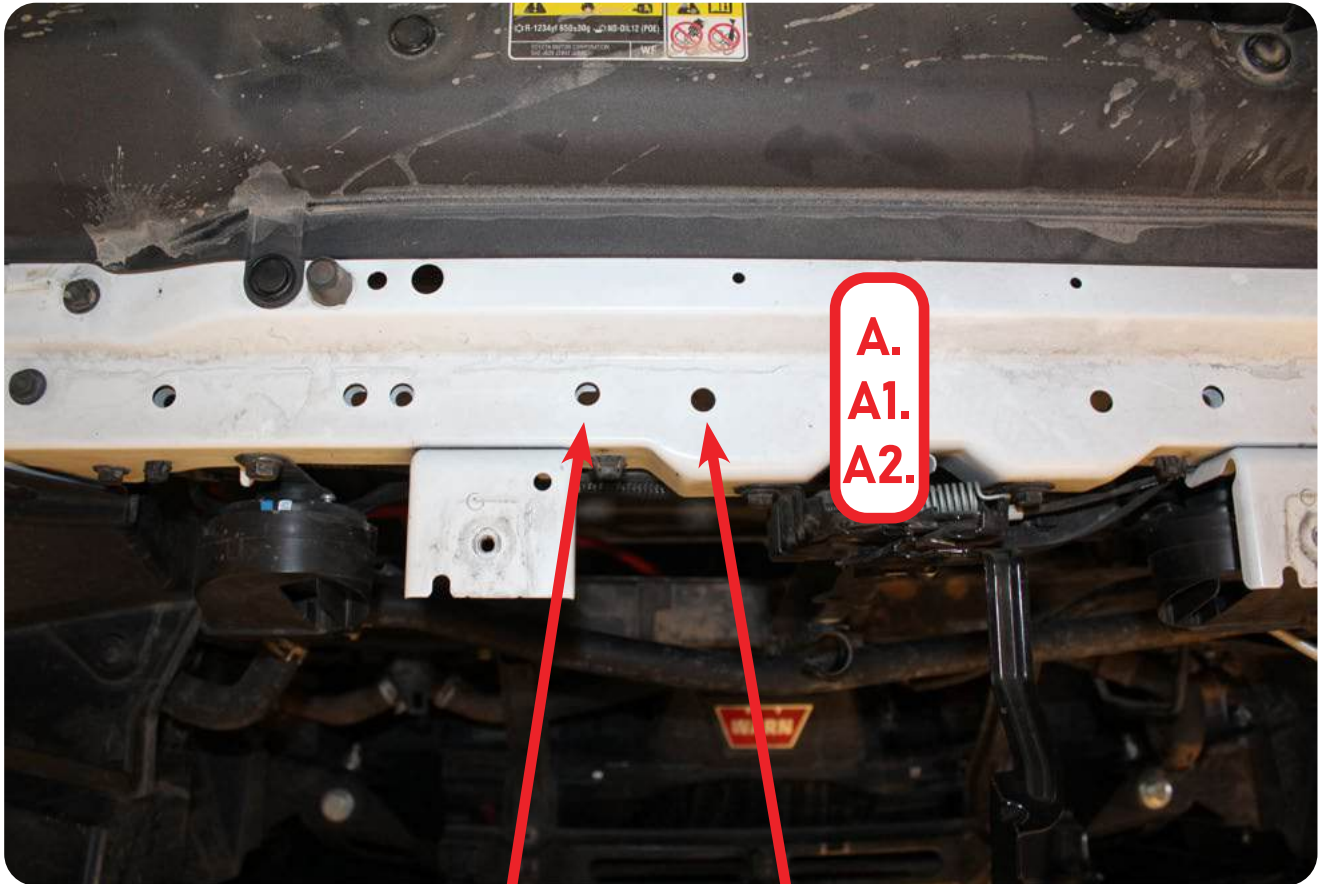



INSTALLATION GUIDE

STEALTH CENTER MOUNT FRONT BUMPER
2022-UP/TOYOTA TUNDRA

INSTALL

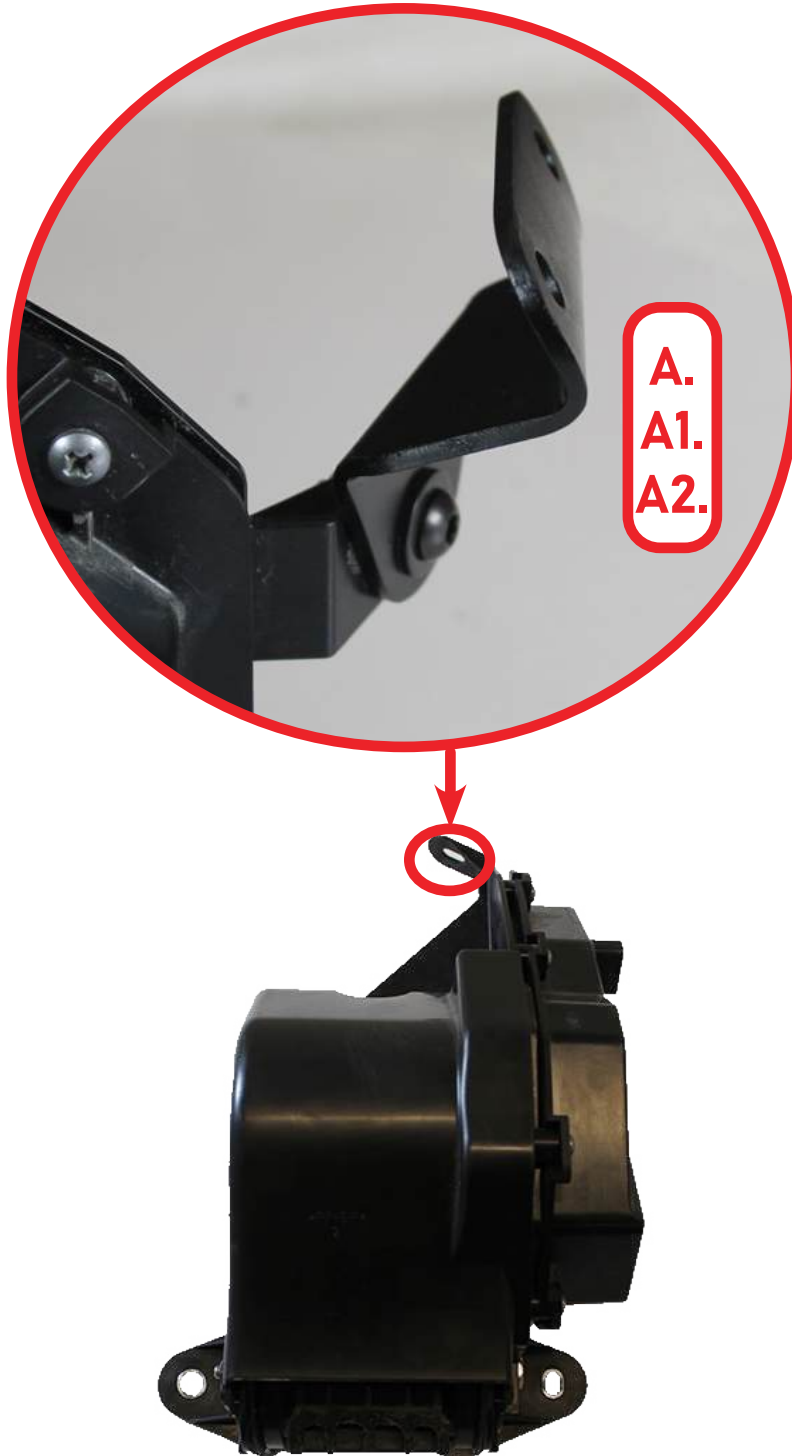



INSTALLATION GUIDE

STEALTH CENTER MOUNT FRONT BUMPER 2022-UP/TOYOTA TUNDRA

INSTALL

□ STEP 14

Keep the coolant line in front of the motor and plug in your air dam motor before re-installing your grill.

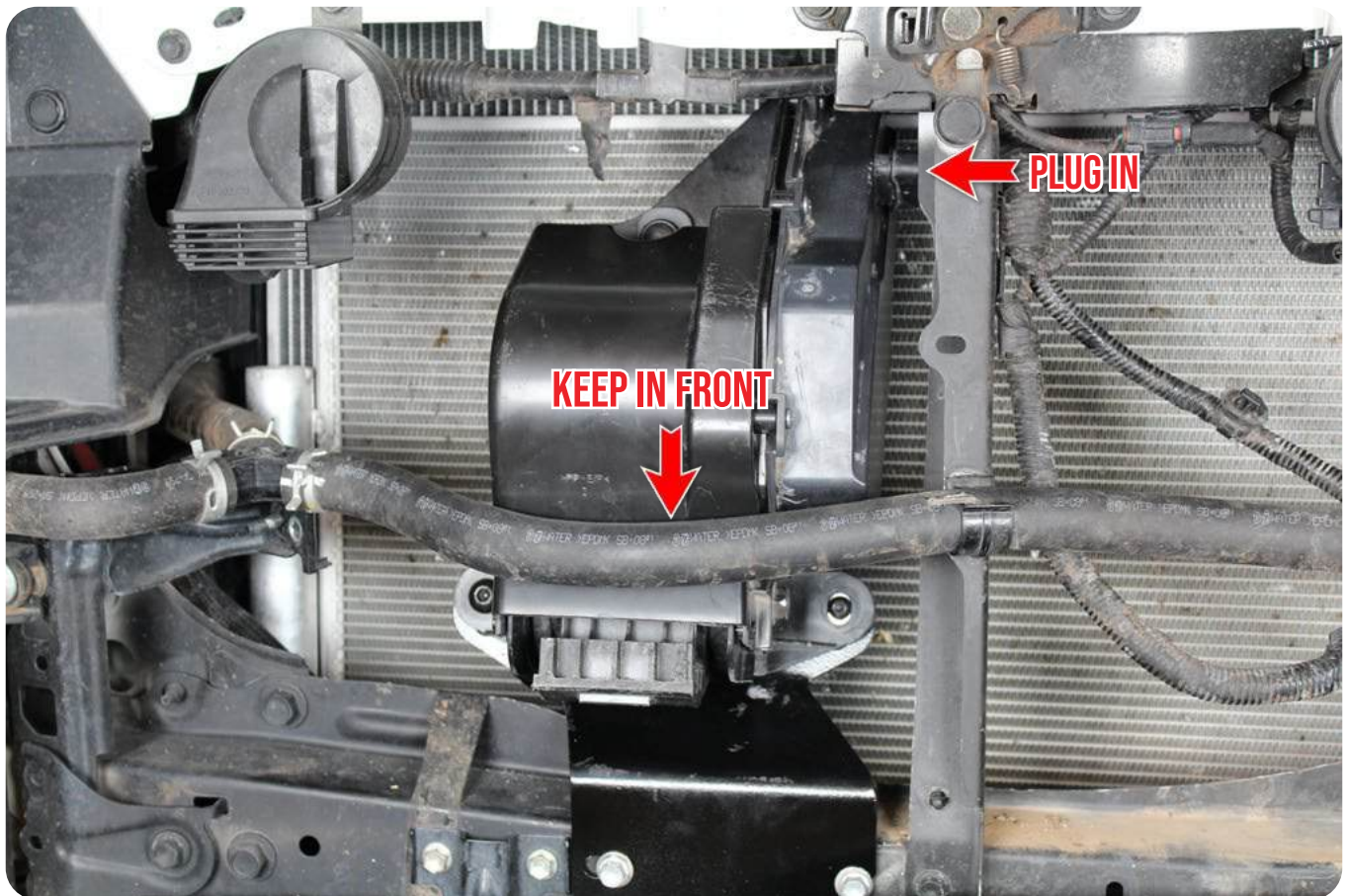

STEALTH CENTER MOUNT FRONT BUMPER 2022-UP/TOYOTA TUNDRA

INSTALL

□ STEP 15

Remove the center plastic from the front assembly by using a (flathead screwdriver) to release the clips shown below.

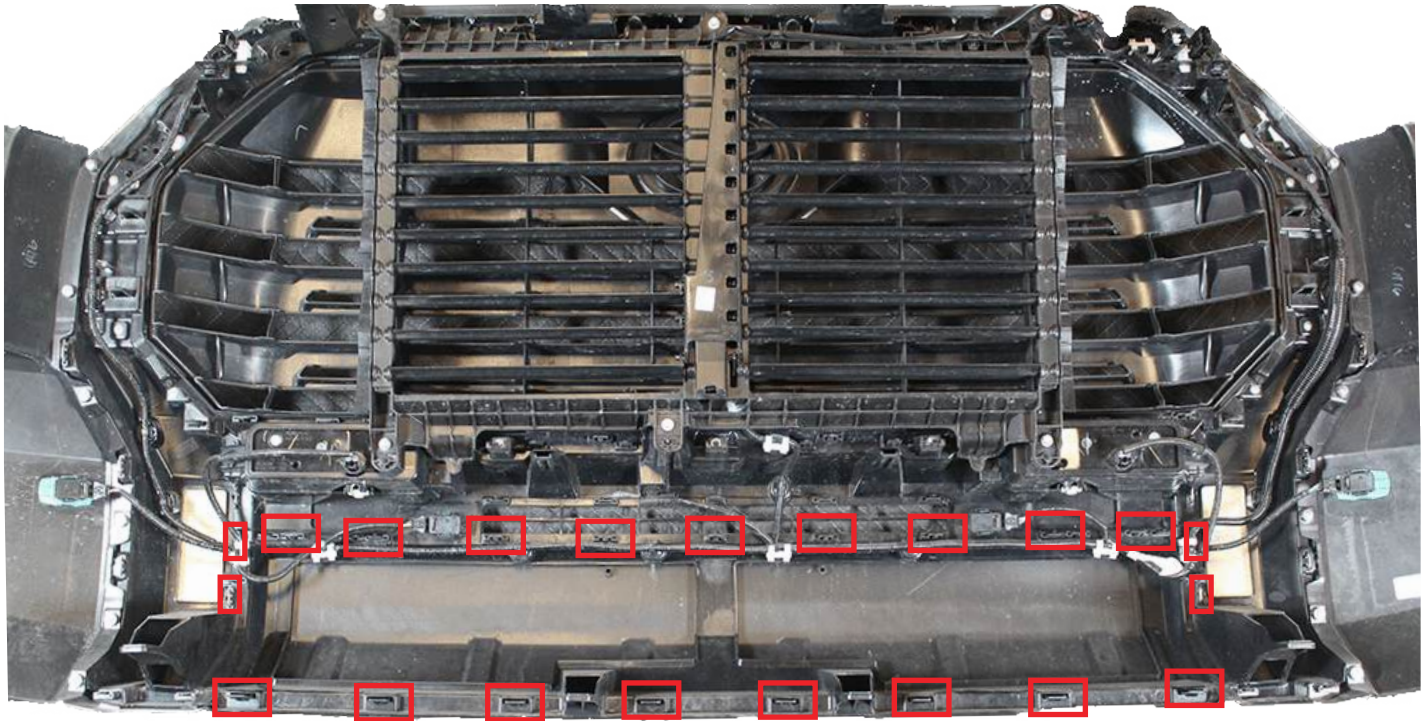

STEALTH CENTER MOUNT FRONT BUMPER 2022-UP/TOYOTA TUNDRA

INSTALL

□ STEP 16

Using a (flathead screwdriver) or a (fastener removal tool), remove the highlighted clips and position the harness away from the center section to avoid any wire damage while cutting.

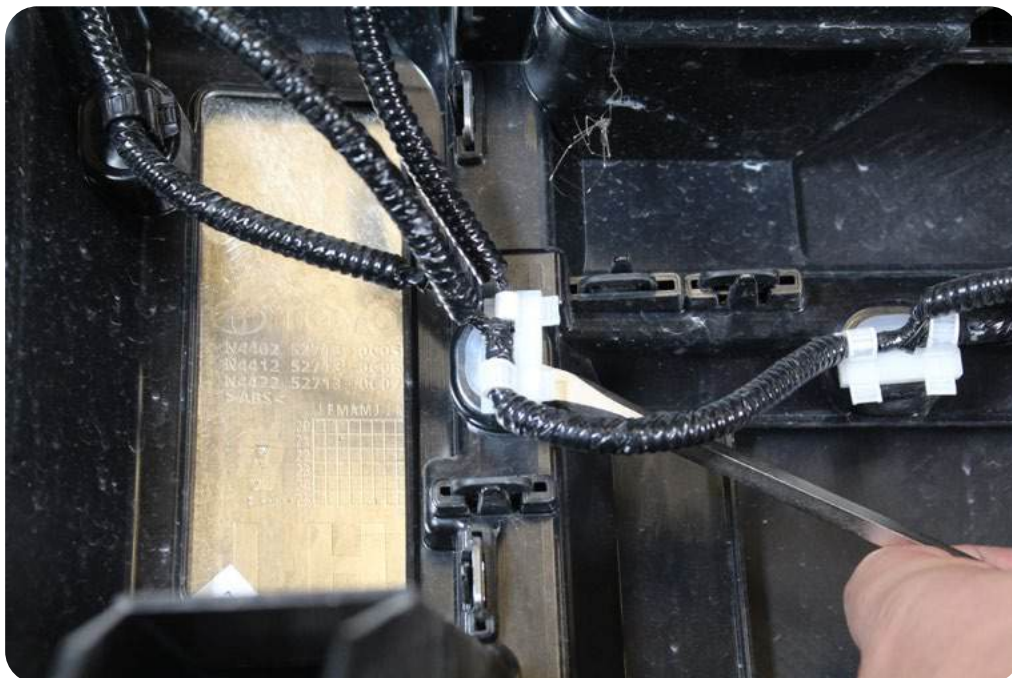
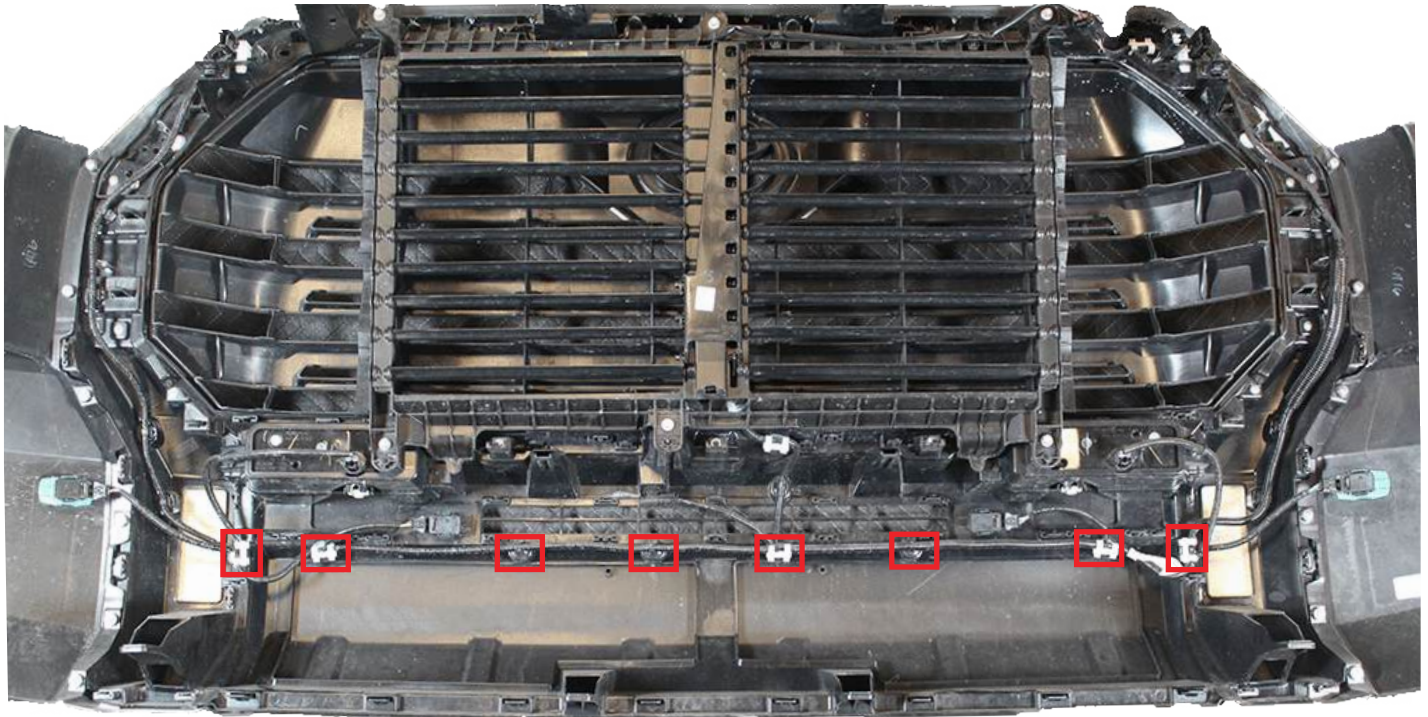

STEALTH CENTER MOUNT FRONT BUMPER 2022-UP/TOYOTA TUNDRA

INSTALL

□ STEP 17

Using a (jigsaw) or your choice of cutting tools, cut along the dotted lines shown below. You may need to remove the bumper later on during the install to fine tune your cut to your desired fitment.

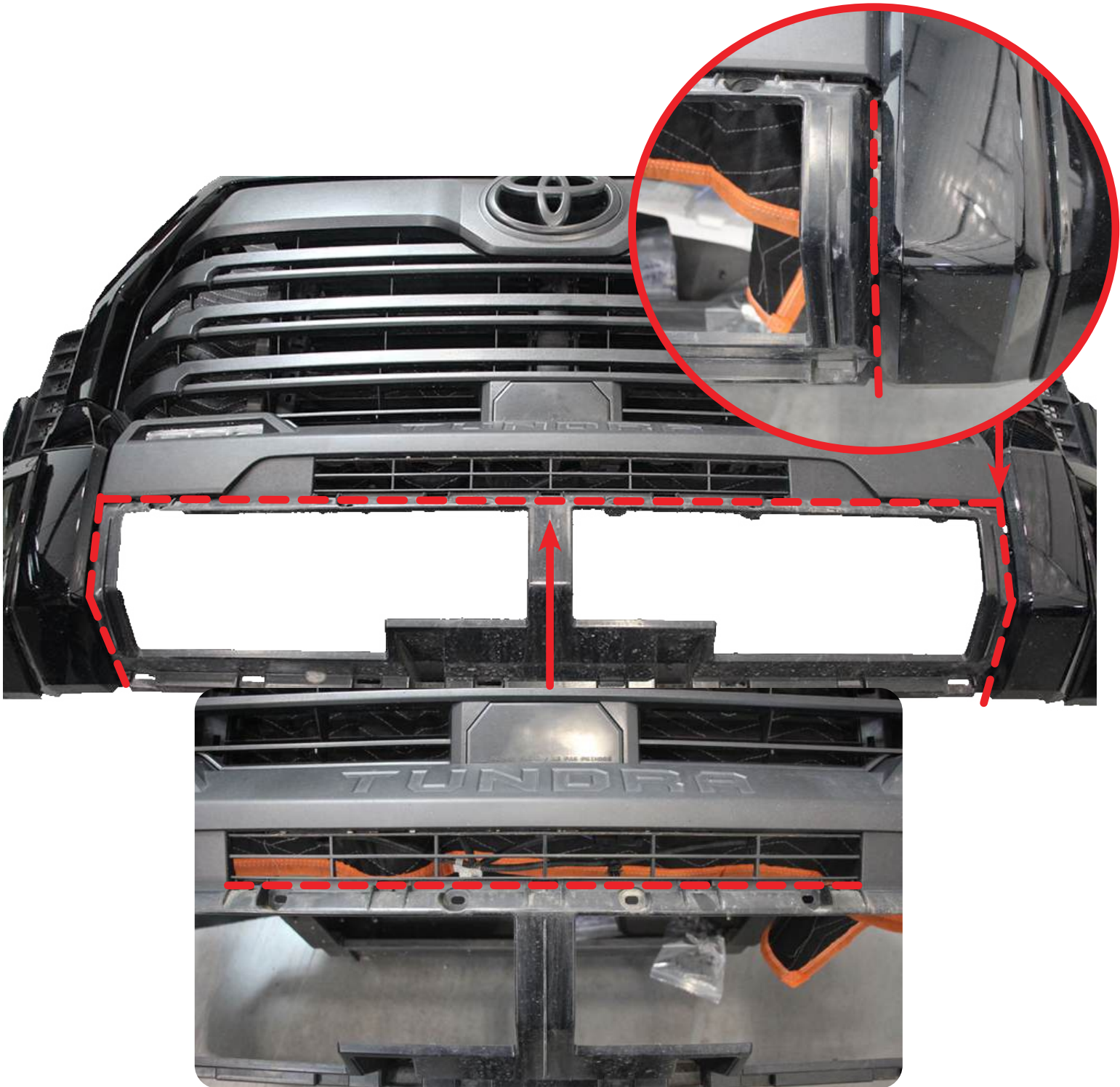

STEALTH CENTER MOUNT FRONT BUMPER 2022-UP/TOYOTA TUNDRA

INSTALL

□ STEP 18

Re-Install the front assembly to the truck and with a helping hand, install the bumper mounts with the provided **(C, C1, C2)** 3/8" hardware as shown below using a (9/16 socket and wrench). Next install the provided **(D, D1, D2)** 1/2" hardware using a (3/4 socket and wrench). ****Tighten the top 1/2" hardware before tightening the 3/8" and OEM hardware****

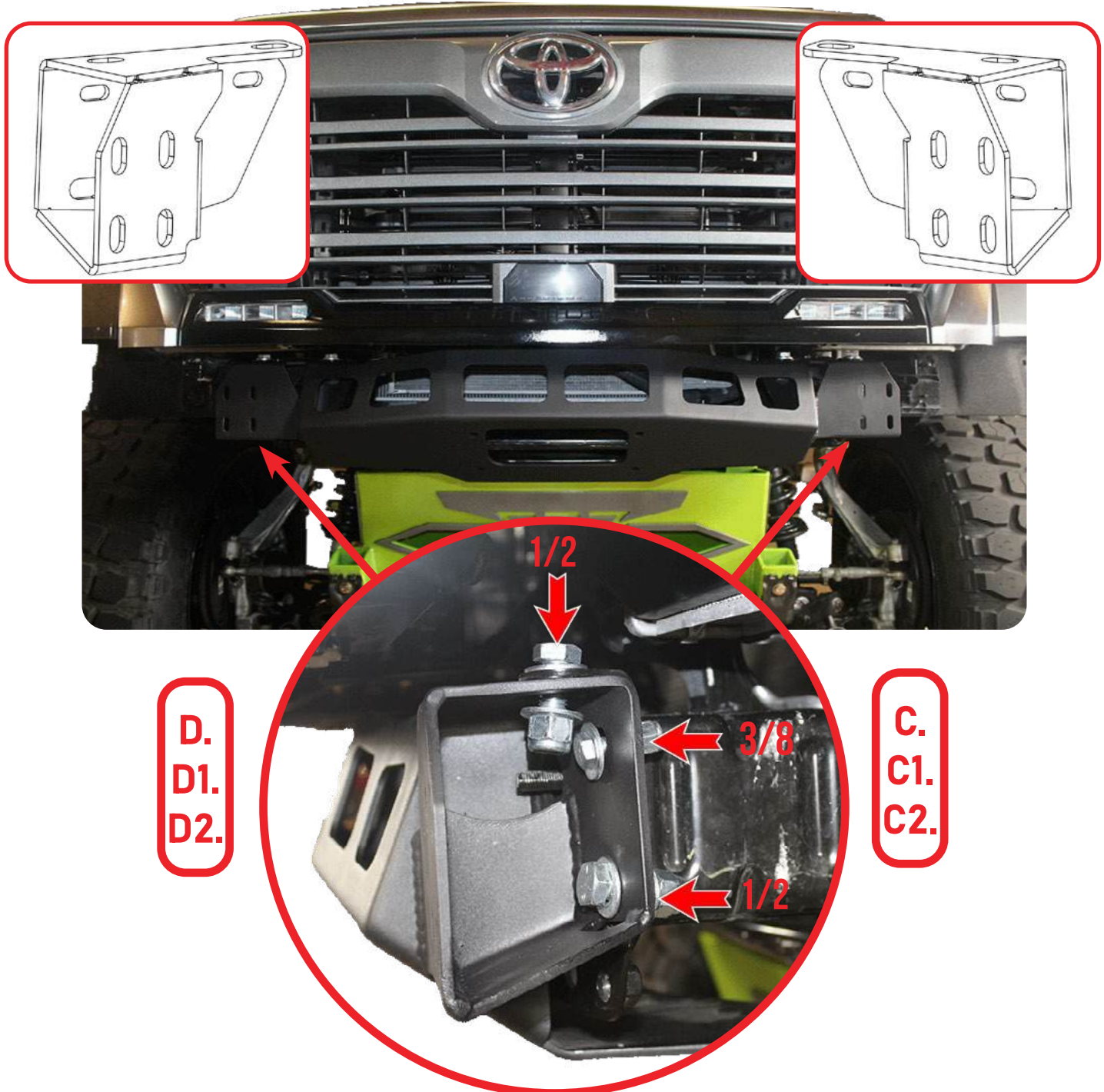



INSTALLATION GUIDE

STEALTH CENTER MOUNT FRONT BUMPER 2022-UP/TOYOTA TUNDRA

INSTALL

□ STEP 19

Install the inside light bar with the provided **(L)** light brackets with the provided **(B, B1, B2)** 3/8" hardware using a (5/32 allen) and a (7/16 wrench).

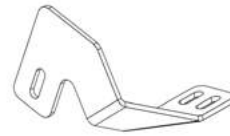

DRIVER

PASSENGER

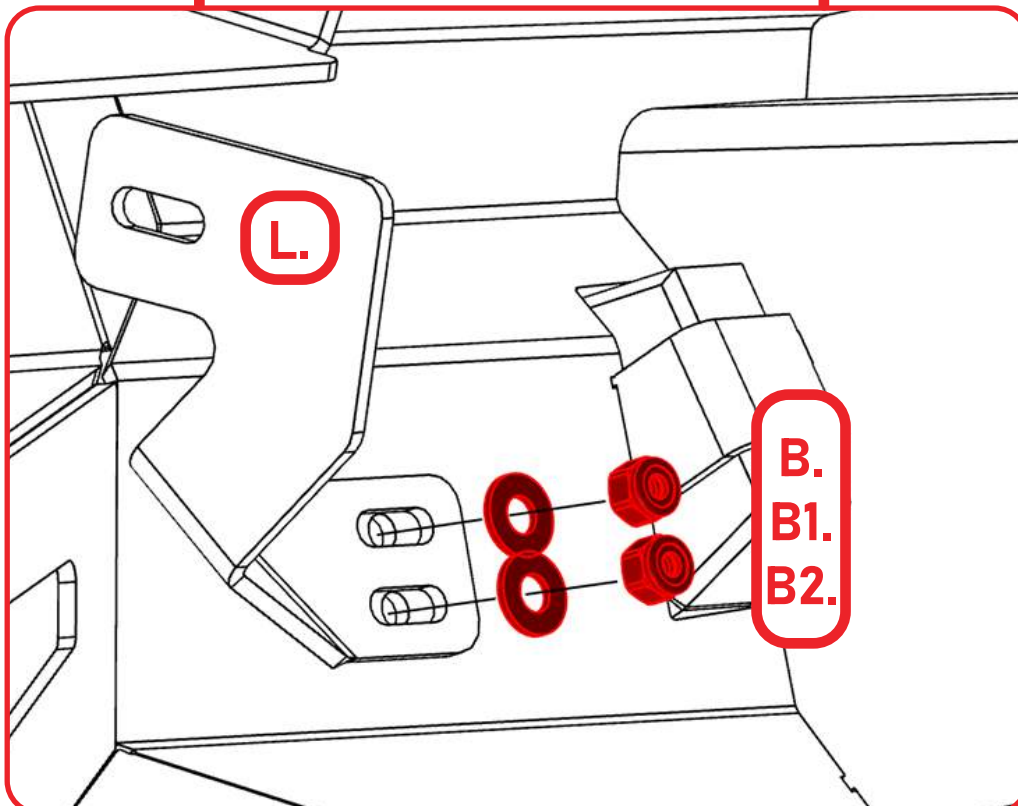
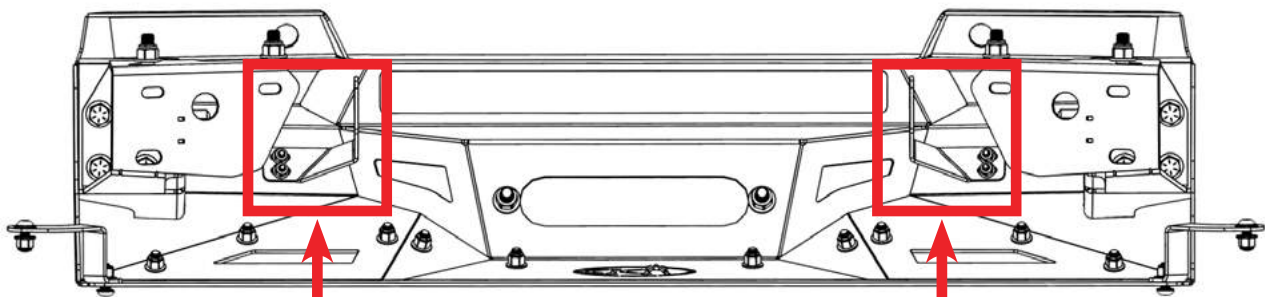

STEALTH CENTER MOUNT FRONT BUMPER 2022-UP/TOYOTA TUNDRA

INSTALL

□ STEP 20

Using a (flathead screwdriver) remove the inner sensor bezels. ****Be careful not to break tabs on top****





STEALTH CENTER MOUNT FRONT BUMPER 2022-UP/TOYOTA TUNDRA

INSTALL

□ STEP 21

Remove double sided tape from the bezel until the surface is clear of residue.





STEALTH CENTER MOUNT FRONT BUMPER 2022-UP/TOYOTA TUNDRA

INSTALL

□ STEP 22

Install (F) 3m double sided tape to each side of the bezel wings and trim excess with a (razor blade).

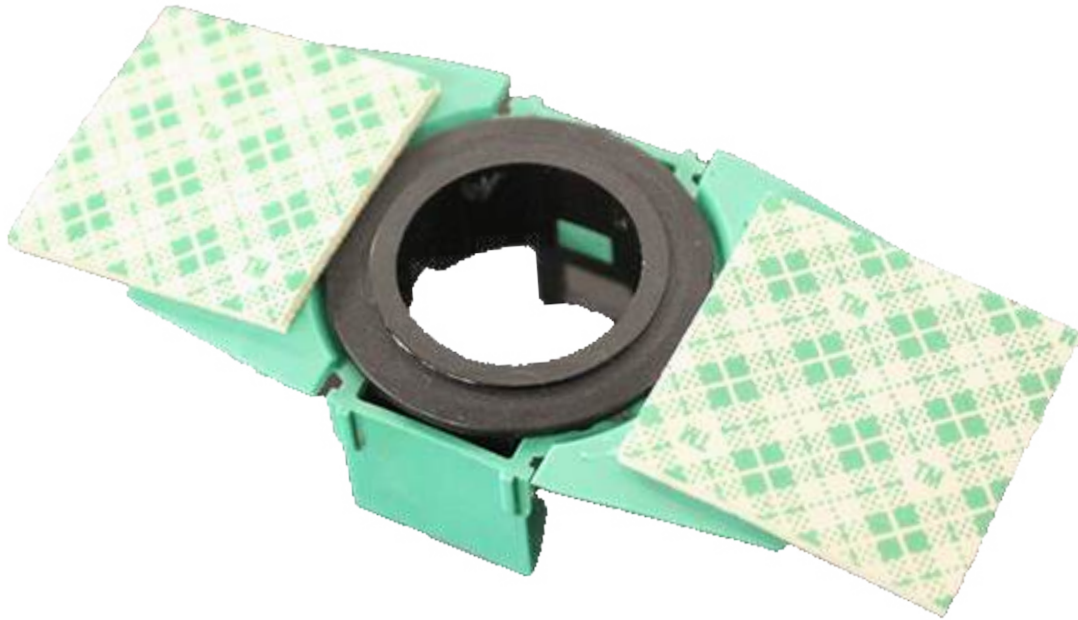

(F.)

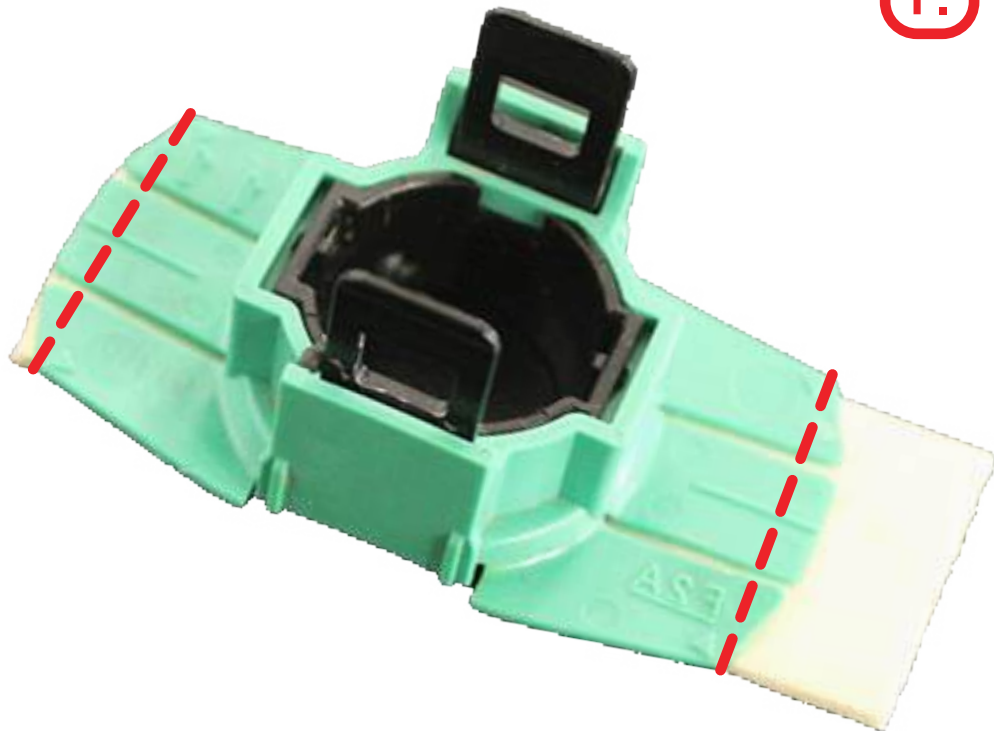

STEALTH CENTER MOUNT FRONT BUMPER 2022-UP/TOYOTA TUNDRA

INSTALL

□ STEP 23

Install the sensor bezel into the locations highlighted below.

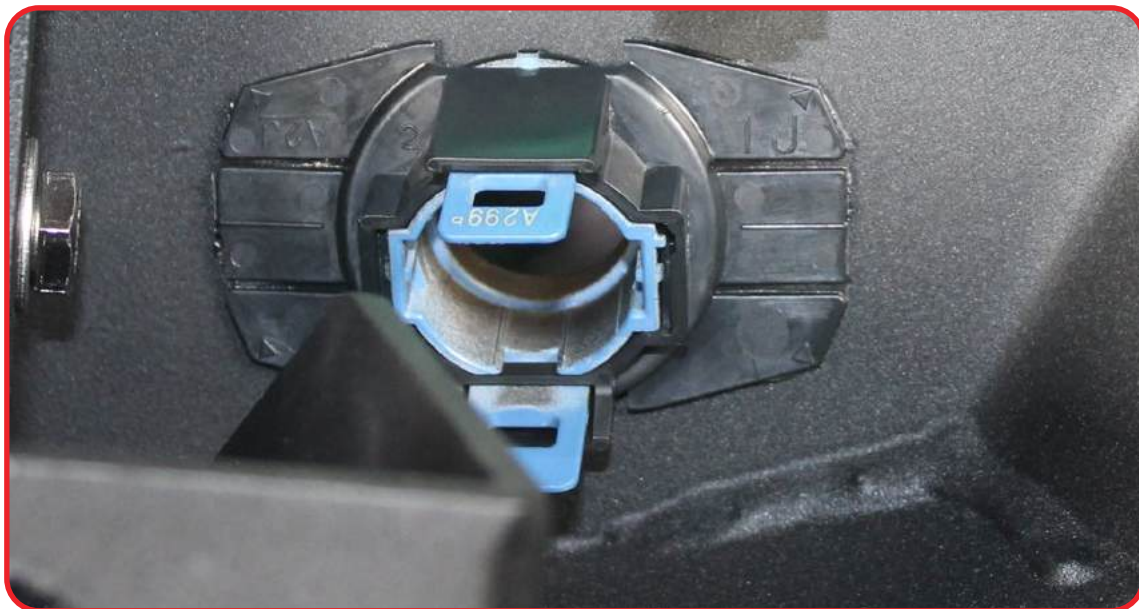
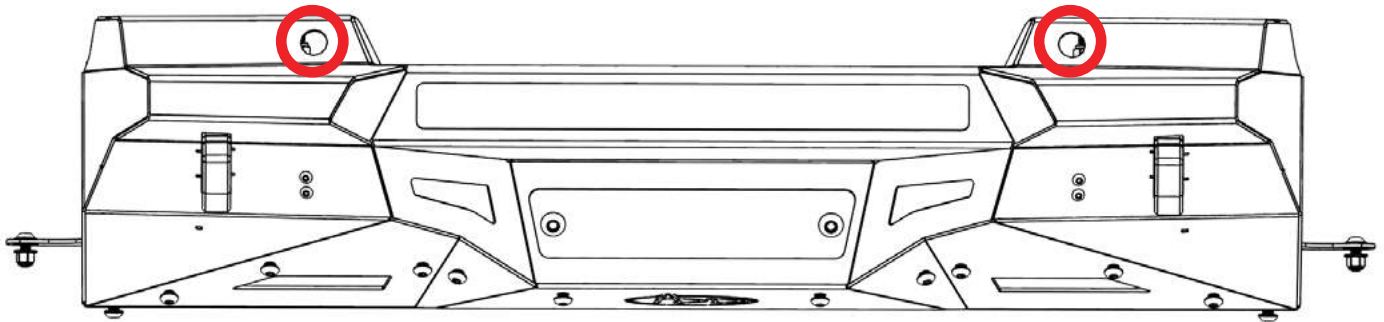



INSTALLATION GUIDE

STEALTH CENTER MOUNT FRONT BUMPER 2022-UP/TOYOTA TUNDRA

INSTALL

□ STEP 24

If you did not purchase a skid plate, install the provided (B, B1, B2) into the holes shown below using a (7/32 allen) and a (9/16 wrench). Do not install the back hardware until later on in the install.

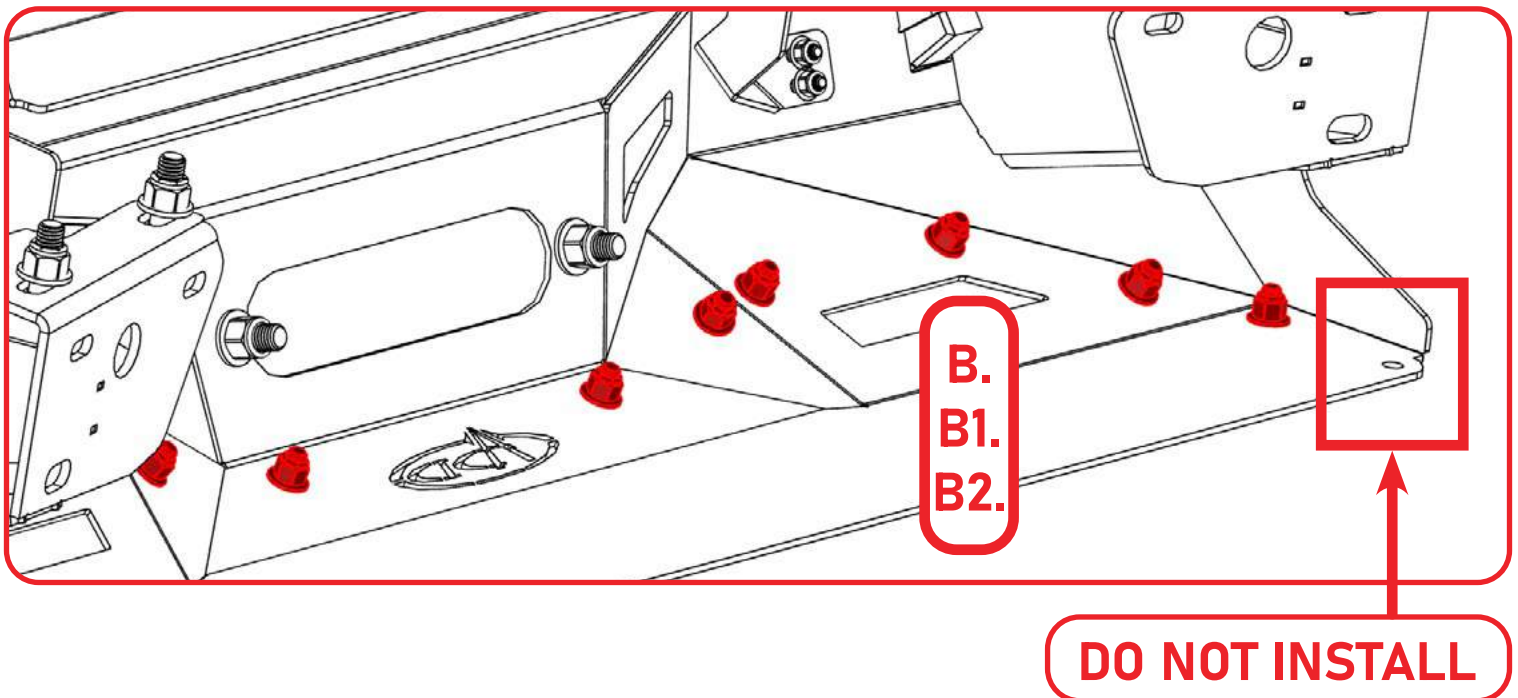
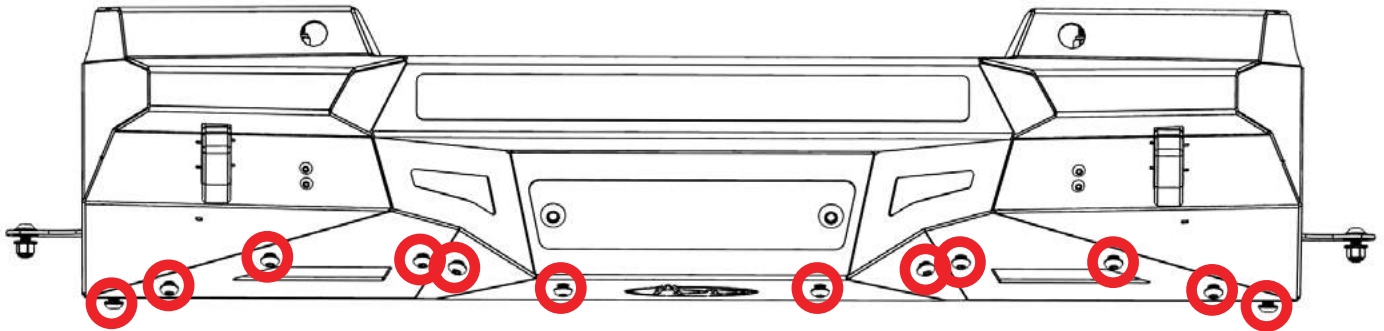



INSTALLATION GUIDE

STEALTH CENTER MOUNT FRONT BUMPER 2022-UP/TOYOTA TUNDRA

INSTALL

□ STEP 25

If you did not purchase a winch mount, install the provided (M) cover plate with the provided (E, E1, E2) 1/2 hardware using a (5/16 allen) and a (3/4 wrench). You can mount this plate on either the outside or inside of the bumper.

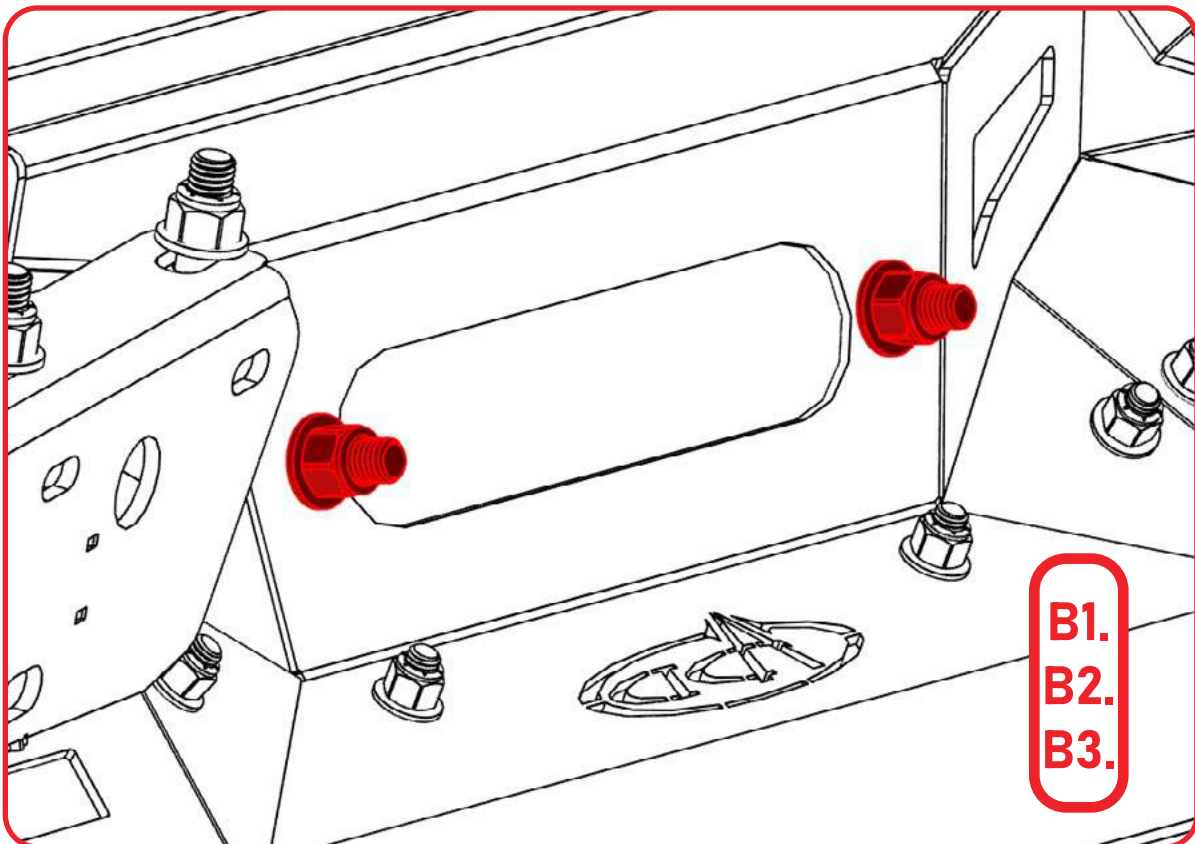
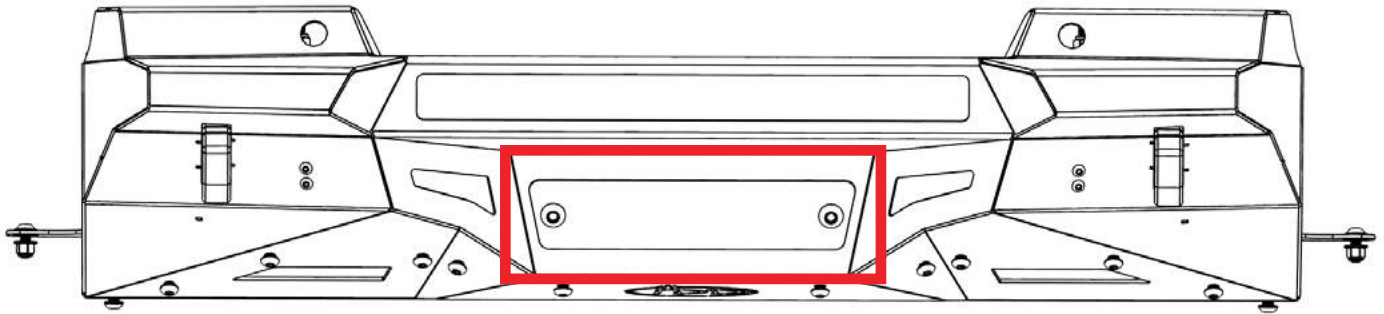



INSTALLATION GUIDE

STEALTH CENTER MOUNT FRONT BUMPER 2022-UP/TOYOTA TUNDRA

INSTALL

□ STEP 26

With a helping hand, install the bumper with the provided (D, D1, D2) 1/2" hardware using a (3/4 wrench) and a (3/4 socket).

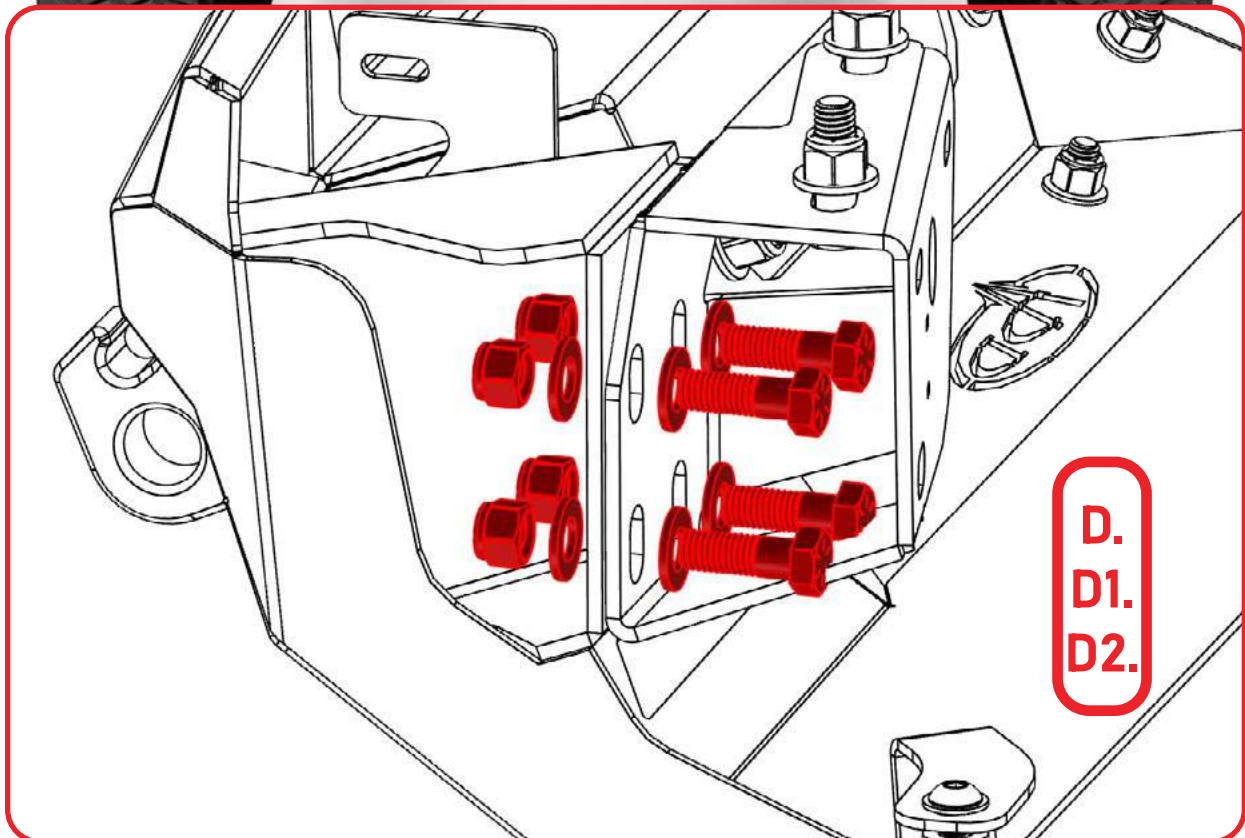
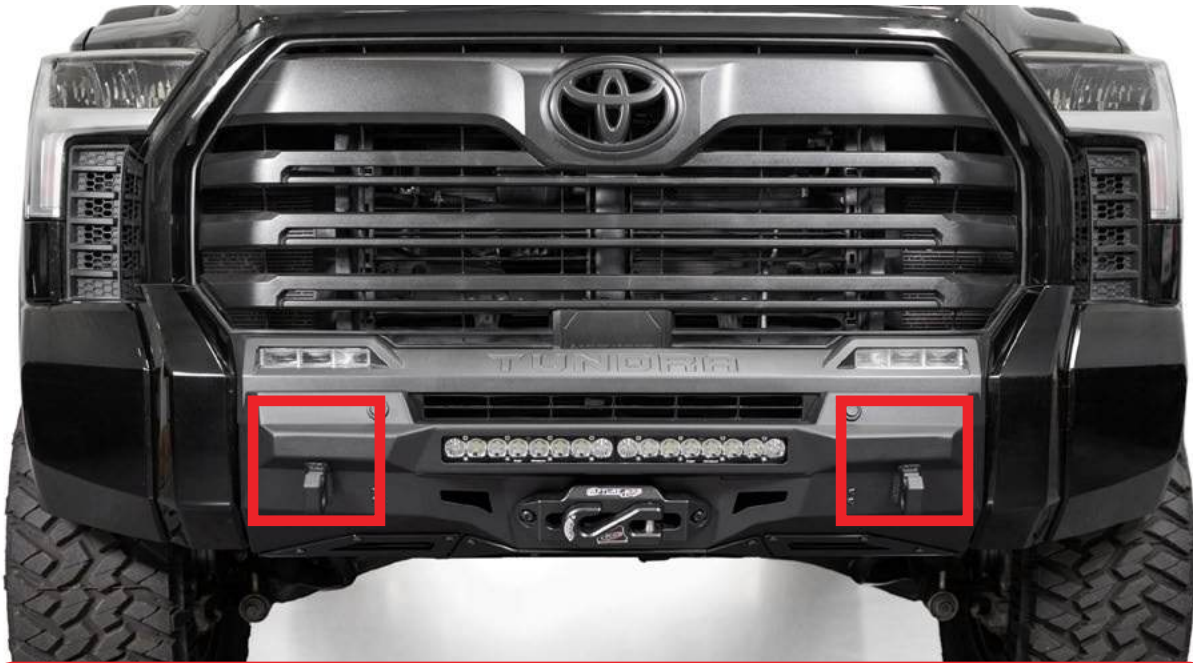



INSTALLATION GUIDE

STEALTH CENTER MOUNT FRONT BUMPER 2022-UP/TOYOTA TUNDRA

INSTALL

□ STEP 27

Install the support brackets (**K**) into the mounting hole from **step 24** with the provided (**B, B1, B2**) 3/8" Hardware using a (7/32 allen) and a (9/16 socket). Next, install the same hardware into the brackets shown on **page 36**.

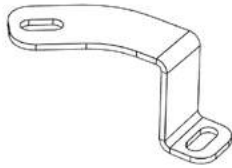

DRIVER

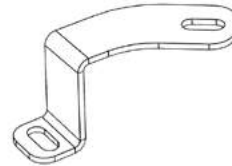

PASSENGER

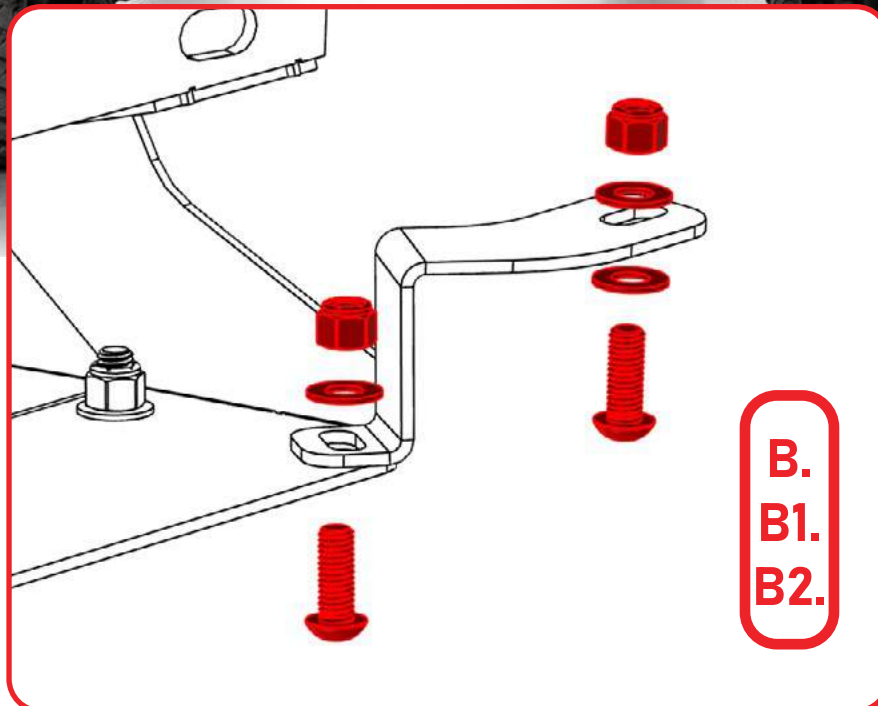
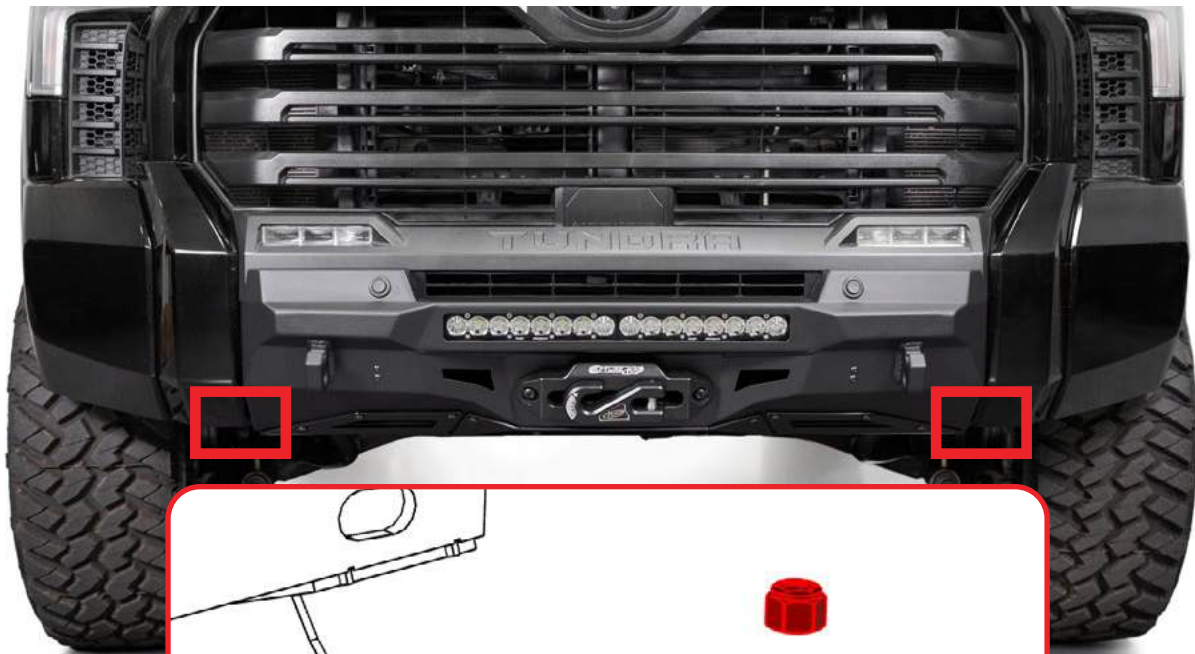



INSTALLATION GUIDE

STEALTH CENTER MOUNT FRONT BUMPER
2022-UP/TOYOTA TUNDRA

INSTALL

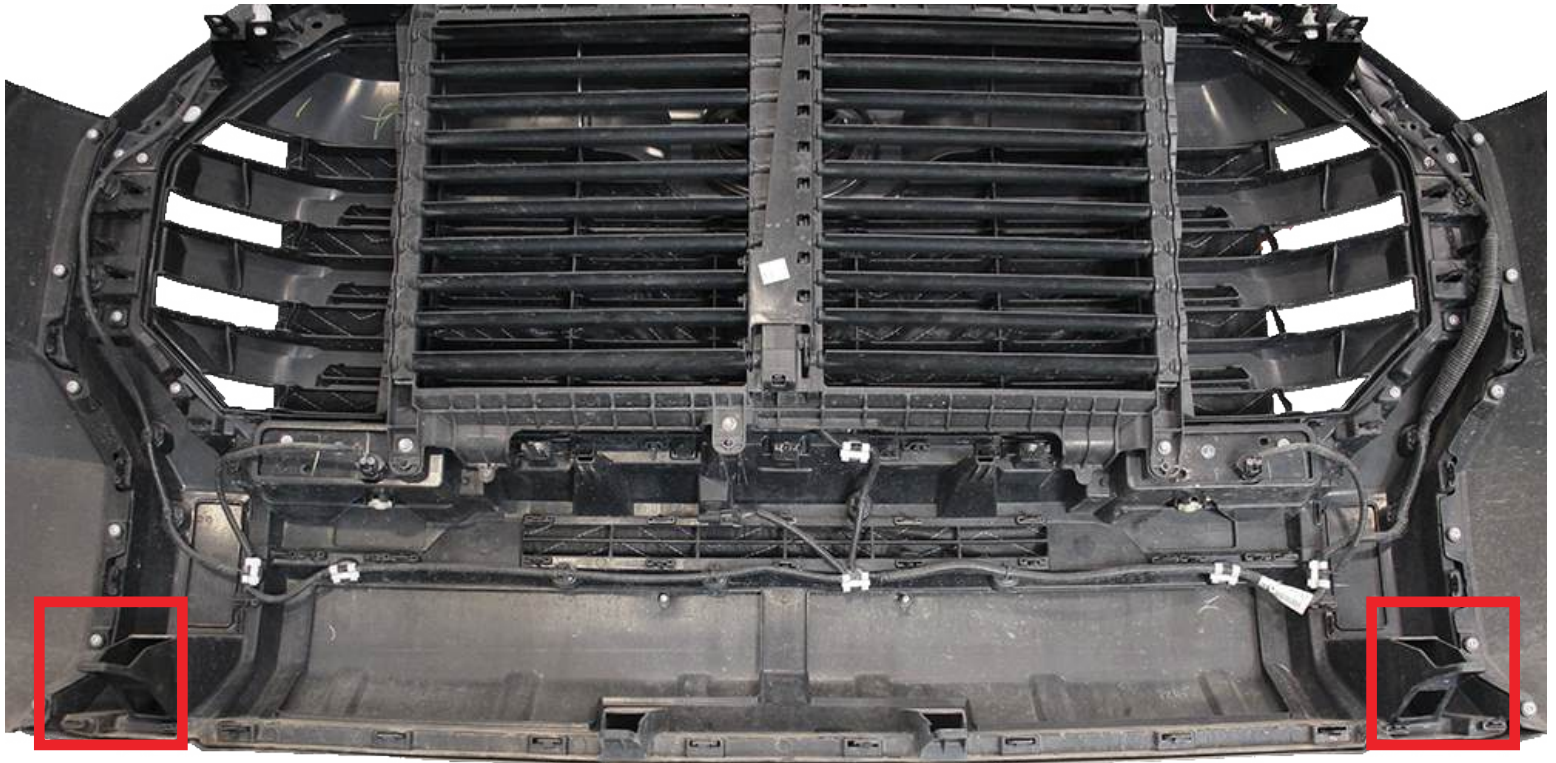



INSTALLATION GUIDE

STEALTH CENTER MOUNT FRONT BUMPER 2022-UP/TOYOTA TUNDRA

INSTALL

□ STEP 28

Re-install the 4x bolts on top of the grill using a (10mm socket).

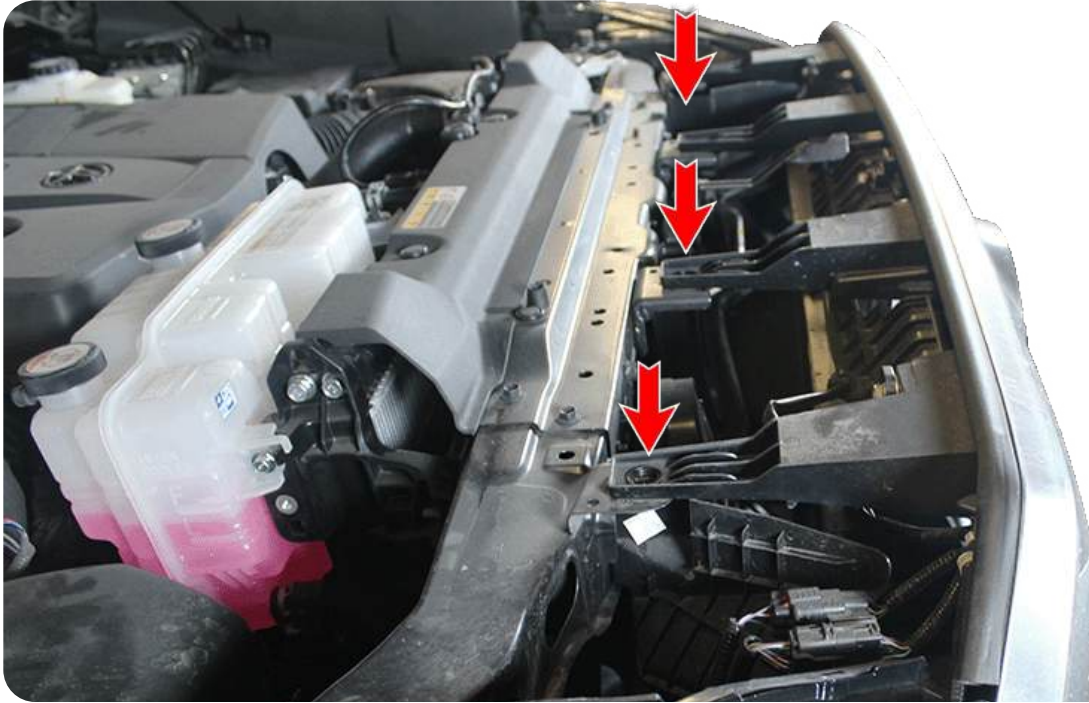

STEALTH CENTER MOUNT FRONT BUMPER 2022-UP/TOYOTA TUNDRA

INSTALL

□ STEP 29

Plug in the 3x wiring harness plugs.

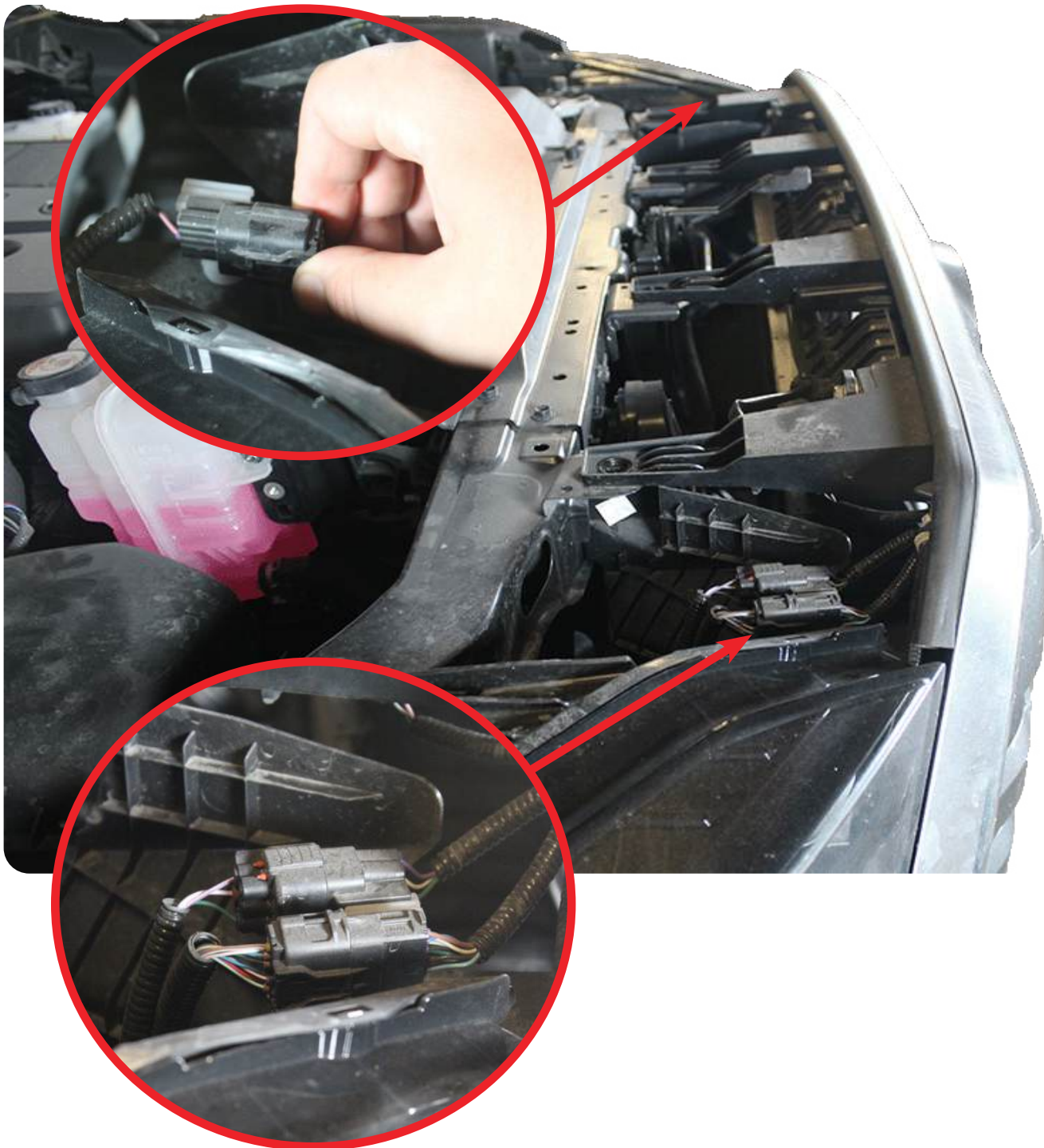



INSTALLATION GUIDE

STEALTH CENTER MOUNT FRONT BUMPER 2022-UP/TOYOTA TUNDRA

FINAL

STEP 30

Stand back and enjoy your new ADD Stealth Center Mount Front Bumper.
Check and re-tighten all mounting bolts after 100 miles and periodically thereafter.



THIS PRODUCT IS PROTECTED BY ONE OR MORE U.S. PATENTS
WWW.ADDICTIVEDESERTDESIGNS.COM/PATENTS

FOR ADDITIONAL SUPPORT OR TECHNICAL QUESTIONS,
PLEASE CALL 480-671-0820 OR
EMAIL INFO@ADDICTIVEDESERTDESIGNS.COM