

2022-UP/CHEVY 1500 STEALTH FIGHTER FRONT BUMPER F140152980103



TOOLS REQUIRED

- (Sockets) 7/16, 1/2, 9/16, 5/8, 3/4, 7mm, 10mm, 15mm, 18mm
- (Box end wrenches) 7/16, 1/2, 9/16, 5/8, 3/4, 7mm, 10mm, 15mm, 18mm
- (Allen wrenches) 7/32
- (Torx) T15
- Fastener remover or flathead screwdriver
- Zip ties
- Ratchet
- Razor/scissors



TIME REQUIRED

- 2.5 hours for OEM Removal/Bumper Install
- 1 Additional Hour for Wiring

****Labor Rates are based on a vehicle with no pre-existing damage. Wiring labor is based on a standard wiring procedure with light switches installed in an easily accessible location. Custom light triggering or switch mounting location will result in a greater labor charge.****



SKILL LEVEL



Easy

****This installation requires 2 people for best results****

⚠️ WARNINGS/CAUTIONS BEFORE STARTING INSTALLATION ⚠️

-BEFORE YOU INSTALL THIS KIT-

Read and understand all instructions, warnings, cautions, & notes contained in this installation instruction guide. Consult your vehicle owner's manual for proper disconnection of electrical and lifting of vehicle if required for installation of this product.

This install may require some technical skills and knowledge of basic mechanical work. If you do not feel that you are capable of performing this install please take this product to a trained professional.

After reading this guide please contact us with any questions or concerns before installing product.
Customer Service (480) 671-0820

Addictive desert designs is not responsible for any bodily injury or harm to you or your vehicle as a result of an improper install.

Proper installation of this kit required knowledge of the factory recommended procedures for removal and installation of original equipment components.

We recommend that the factory shop manual and any special tools needed to service your vehicle be on hand during the installation. Installation of this kit without proper knowledge of the factory recommended procedures may affect the performance of these components and the safety of the vehicle.

Inspect all contents of this package to make sure product is not damaged and all installation hardware has been included. If parts are missing from kit, please be prepared to provide the following information:

1. Name of purchase location
2. Bar Code on side of box
3. Date above bar code
4. Date inside box cover

ALWAYS WEAR EYE PROTECTION WHEN OPERATING POWER TOOLS

HARDWARE/PARTS

A.



5/16-18 X 1" HEX HEAD BOLT BLACK

QTY: 2

A1.



5/16 FLAT WASHER

QTY: 4

A2.



5/16-18" NYLON LOCK NUT

QTY: 2

B.



3/8-16 X 1" HEX HEAD BOLT YELLOW

QTY: 2

B1.



3/8" FLAT WASHER YELLOW

QTY: 4

C.



3/8-16 X 1" BUTTON HEAD BOLT BLACK

QTY: 4

C1.



3/8-16" NYLON LOCK NUT BLACK

QTY: 8

C2.



3/8" FLAT WASHER BLACK

QTY: 6

D.



3/8-16 X 1" CARRIAGE BOLT BLACK

QTY: 2

E.

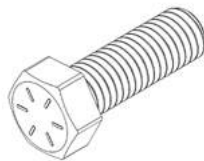

1/2-13 X 1 1/2" BUTTON HEAD BOLT YELLOW

QTY: 6

E1.



1/2 FLAT WASHER YELLOW

QTY: 28

E2.



1/2-13 NYLON LOCK NUT YELLOW

QTY: 18

F.



1/2-16 X 1 1/2" CARRIAGE BOLT YELLOW

QTY: 8

F1.



1/2" RETAINING WASHER

QTY: 8

G.

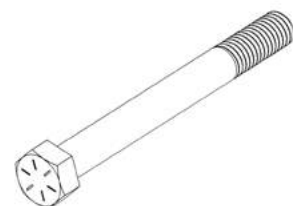

1/2-13 X 4" HEX HEAD BOLT YELLOW

QTY: 4

HARDWARE/PARTS

SENSOR GROMMETS SUPPLIED FOR NON SENSOR TRIMS



3/4" RUBBER SENSOR GROMMET
QTY: 4

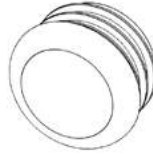

3/4" PLASTIC SENSOR GROMMET PLUG
QTY: 4

H.



SAD0010, SAD0010-M

QTY: 1

I.

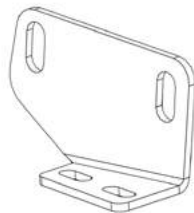

SSF1064, SSF1064-M

QTY: 1

STEALTH FIGHTER FRONT BUMPER 2022-UP/CHEVY 1500

REMOVAL

□ STEP 1

Using a (T15 torx), remove the hood handle as shown below. **(Keep hardware)**

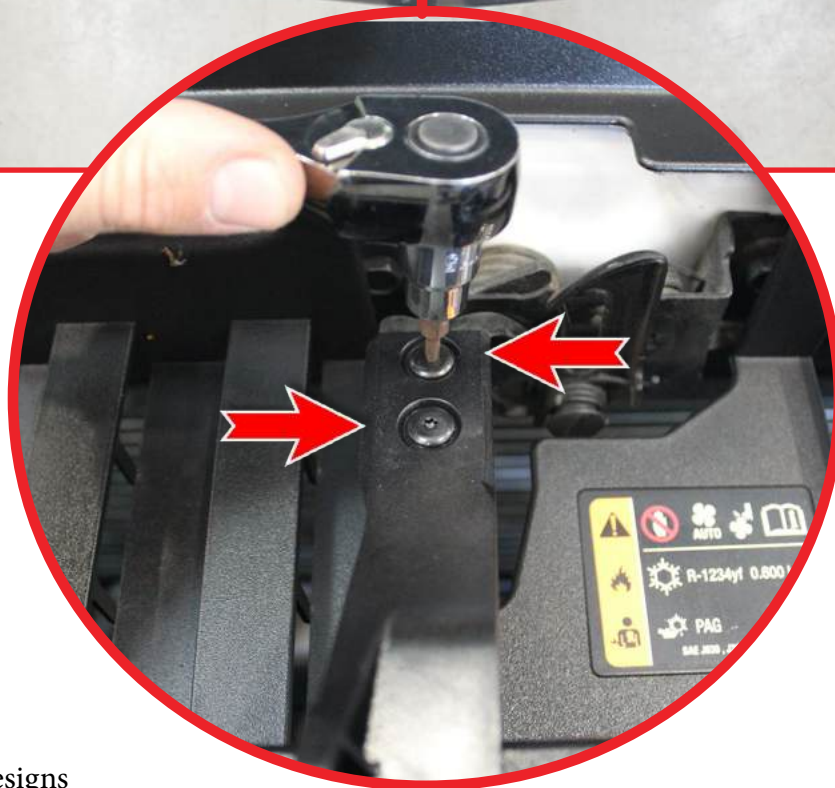

STEALTH FIGHTER FRONT BUMPER 2022-UP/CHEVY 1500

REMOVAL

□ STEP 2

Using a (fastener remover), remove the push pins as shown below. (Keep hardware)



STEALTH FIGHTER FRONT BUMPER 2022-UP/CHEVY 1500

REMOVAL

□ STEP 3

Using a (10mm socket), remove the 4x bolts holding the grill. **(Keep hardware)**

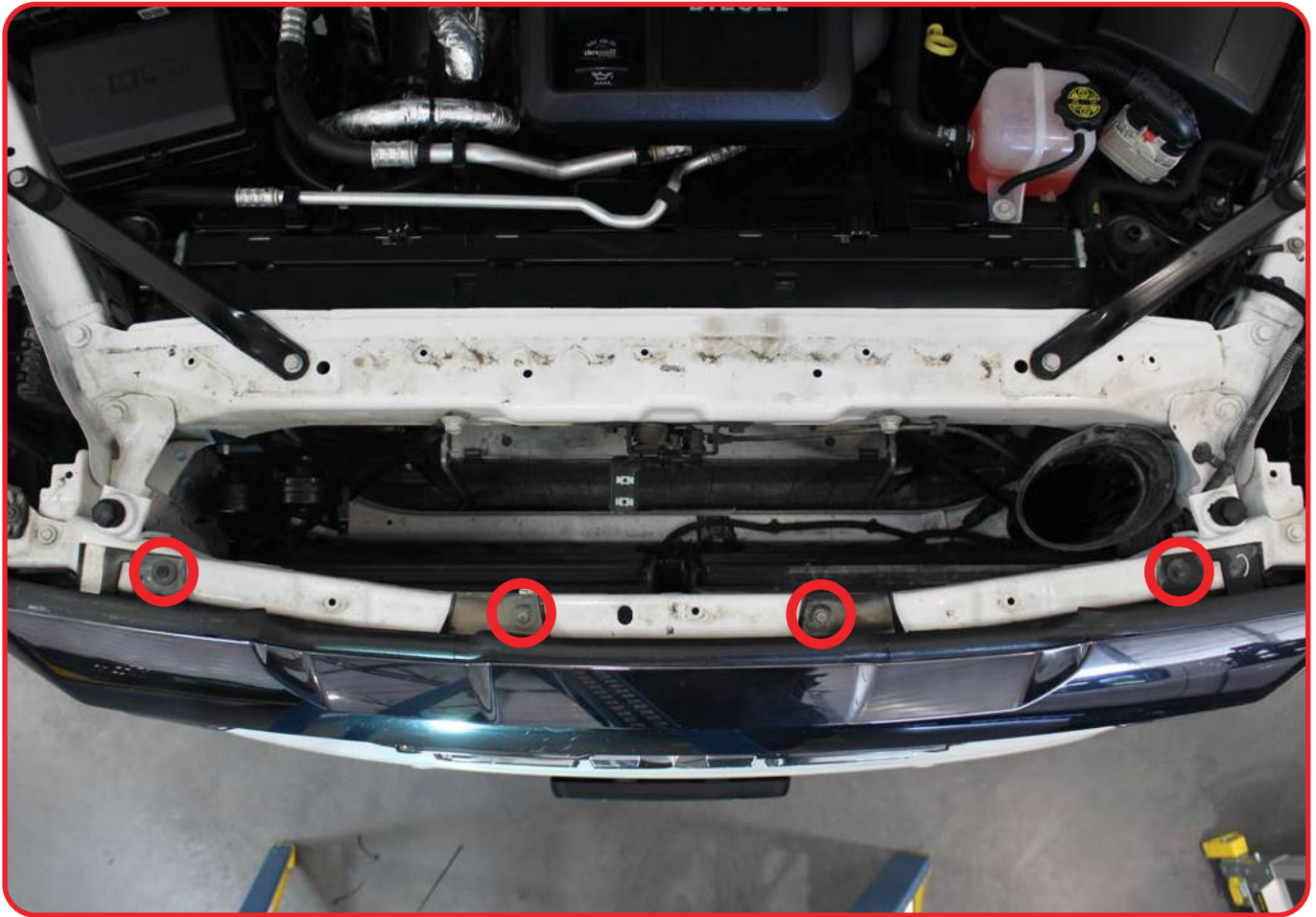

STEALTH FIGHTER FRONT BUMPER 2022-UP/CHEVY 1500

REMOVAL

□ STEP 4

Using a (T15 torx), remove the 2x bolts located inside the wheel well as shown below. (Keep hardware)

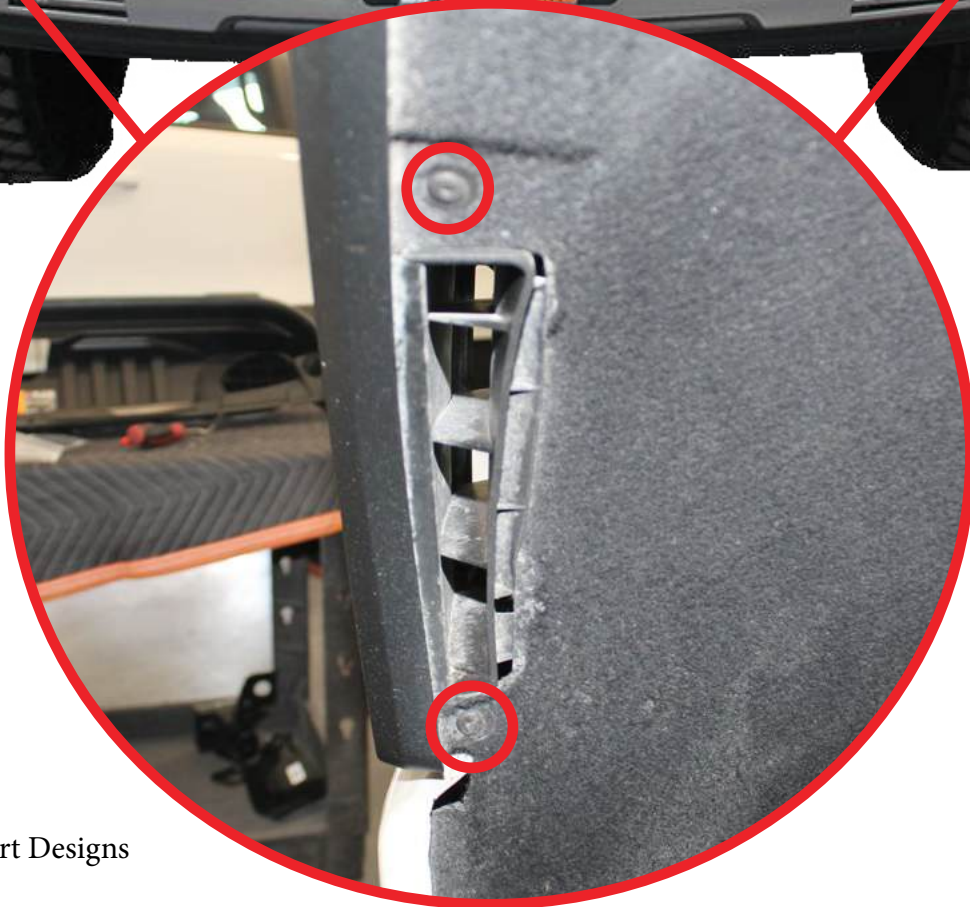

STEALTH FIGHTER FRONT BUMPER 2022-UP/CHEVY 1500

REMOVAL

□ STEP 5

Using a (7mm socket), locate and loosen the OEM bolts inside the wheel well on both sides as shown below.

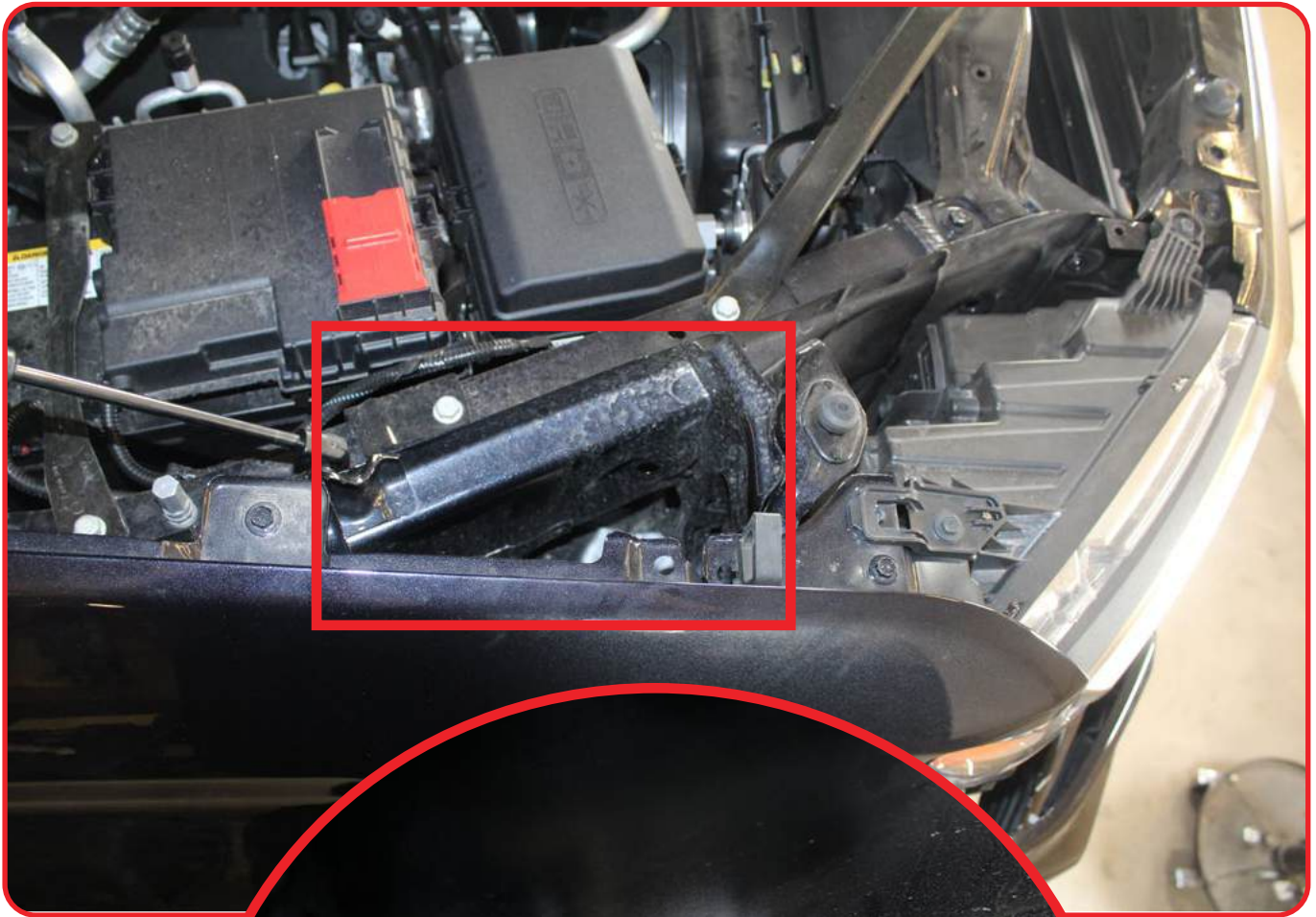

STEALTH FIGHTER FRONT BUMPER 2022-UP/CHEVY 1500

REMOVAL

□ STEP 6

Using a (10mm socket), remove the OEM bolts located on the bottom of the grill. **(Keep hardware)**



STEALTH FIGHTER FRONT BUMPER 2022-UP/CHEVY 1500

REMOVAL

STEP 7

Unplug the front camera and the washer fluid line and remove the grill.



STEALTH FIGHTER FRONT BUMPER 2022-UP/CHEVY 1500

REMOVAL

□ STEP 8

Using a (fastener remover), remove the push pins holding the plastic flashing as shown below. (Keep hardware)

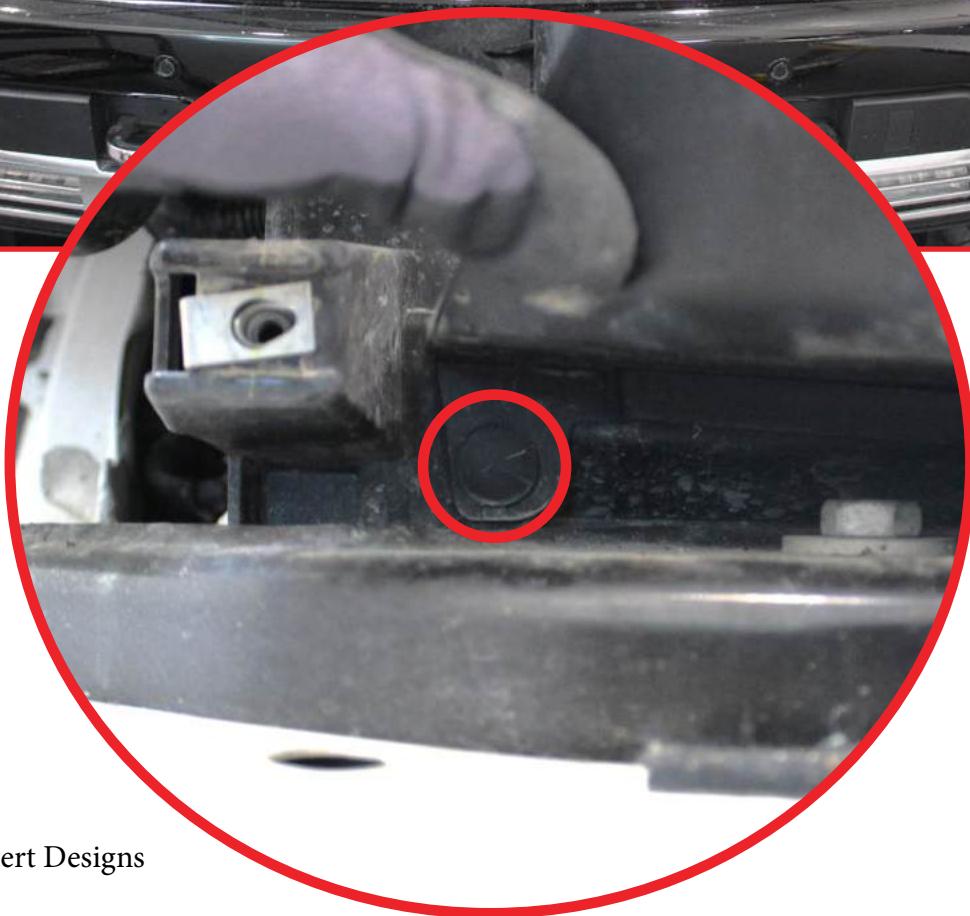

STEALTH FIGHTER FRONT BUMPER 2022-UP/CHEVY 1500

REMOVAL

□ STEP 9

Unplug the main wiring harness, it's located on the passenger side above the bumper.



STEALTH FIGHTER FRONT BUMPER 2022-UP/CHEVY 1500

REMOVAL

□ STEP 10

Using a (3/4 socket), remove the 4x OEM bolts located on top of the bumper.

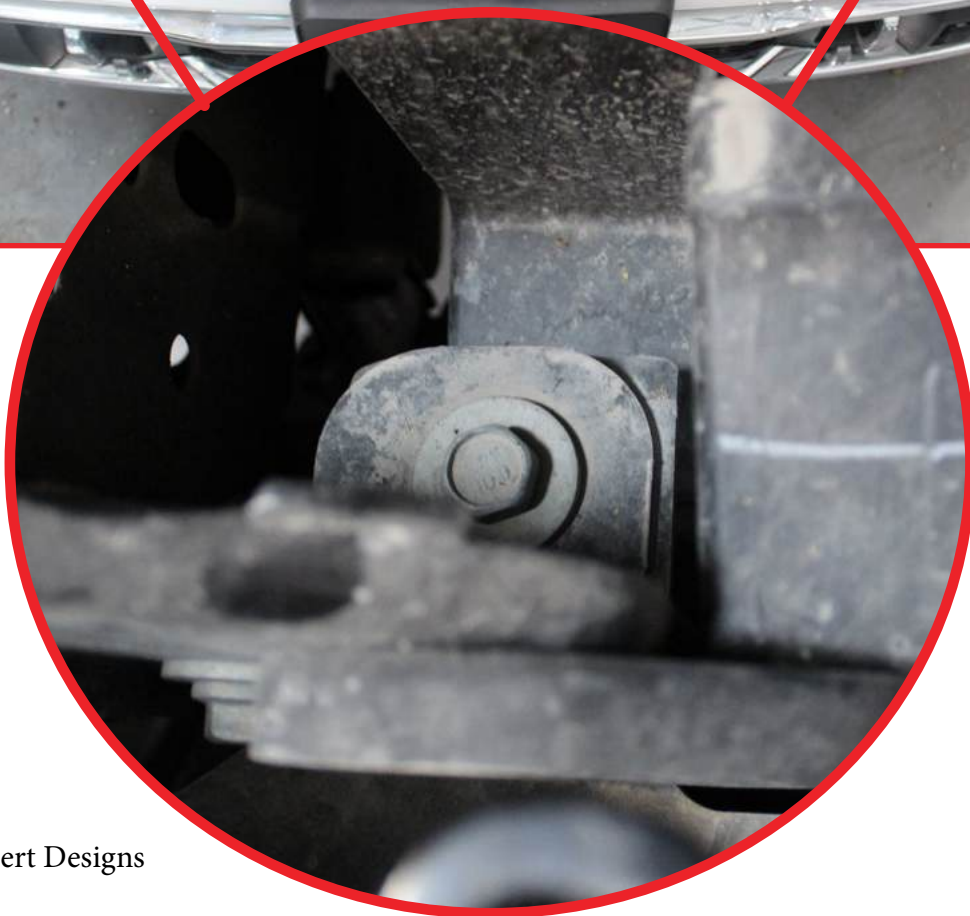
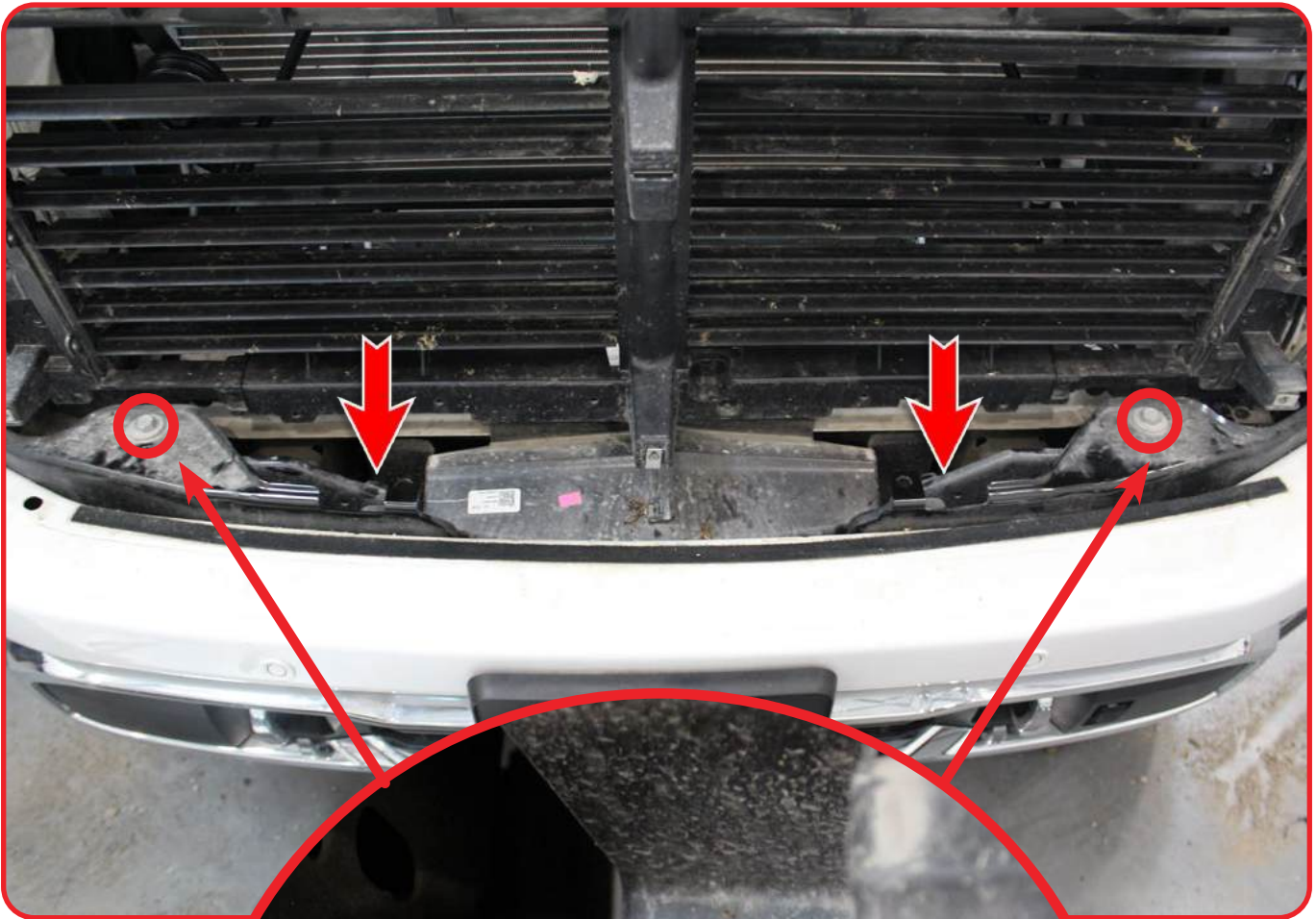

STEALTH FIGHTER FRONT BUMPER 2022-UP/CHEVY 1500

REMOVAL

□ STEP 11

Using a (5/8 socket), remove the bumper supports located under the bumper.

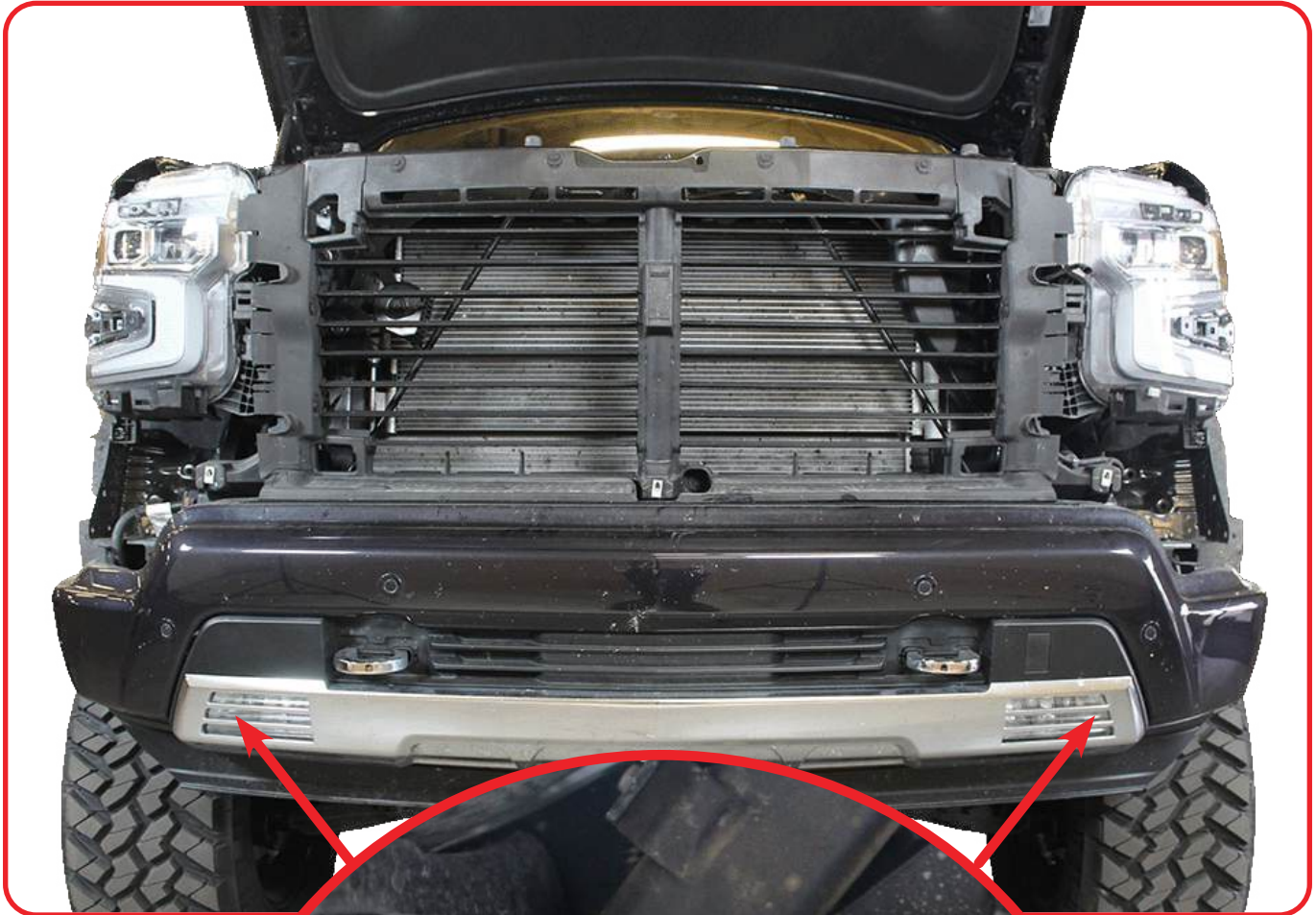

STEALTH FIGHTER FRONT BUMPER 2022-UP/CHEVY 1500

REMOVAL

□ STEP 12

Using a (10mm Socket), remove the 4x bolts located under the bumper as shown below.

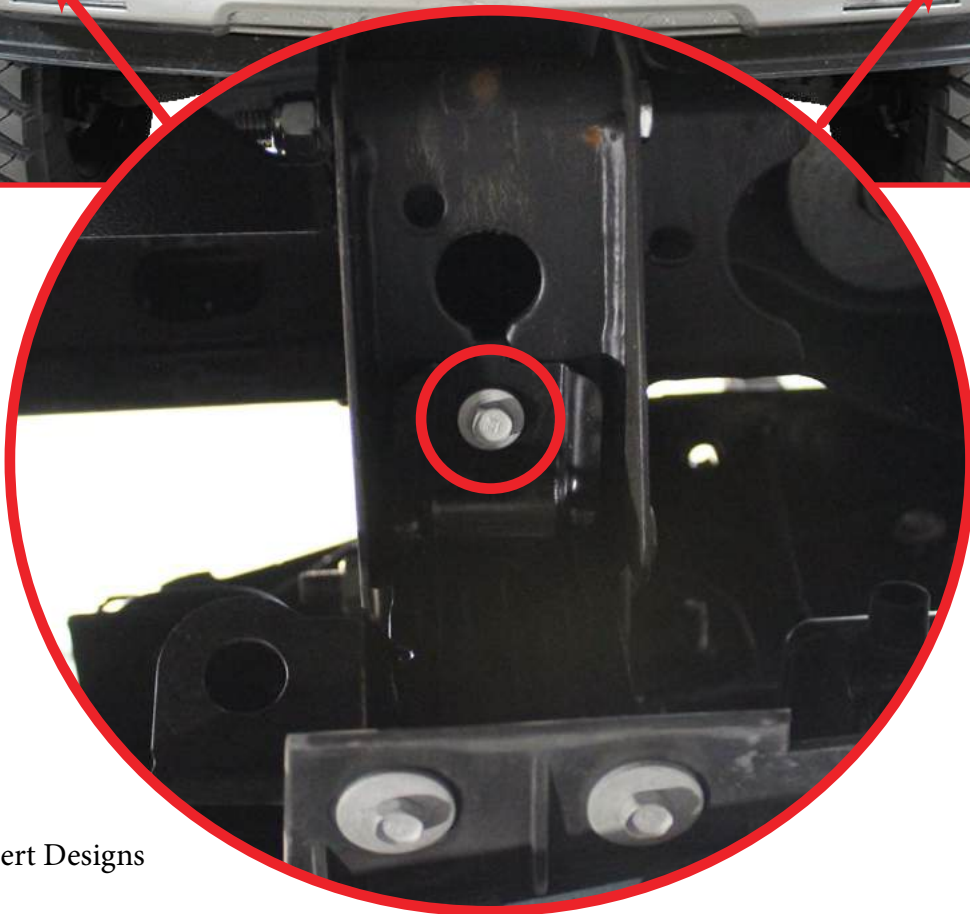
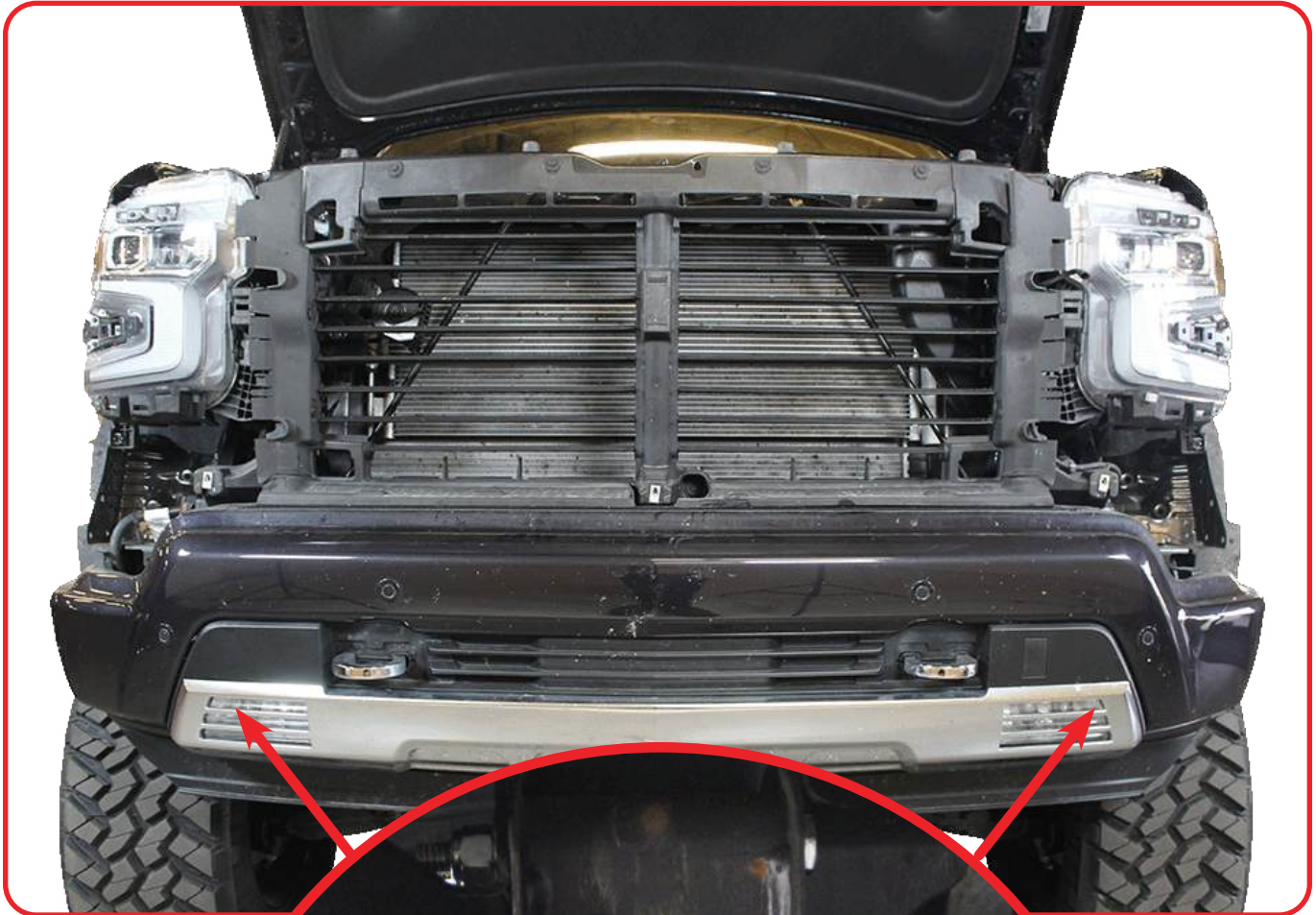

STEALTH FIGHTER FRONT BUMPER 2022-UP/CHEVY 1500

REMOVAL

□ STEP 13

Using a (18mm socket) remove the 4x tow hook mounting bolts.

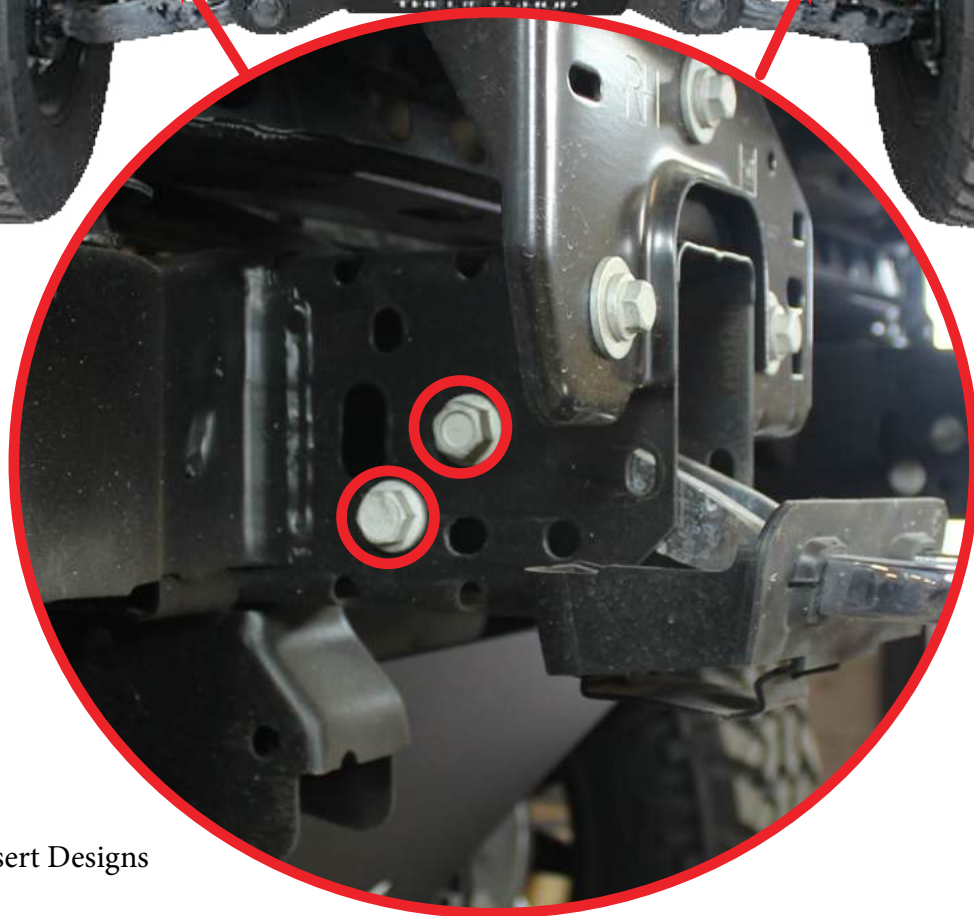
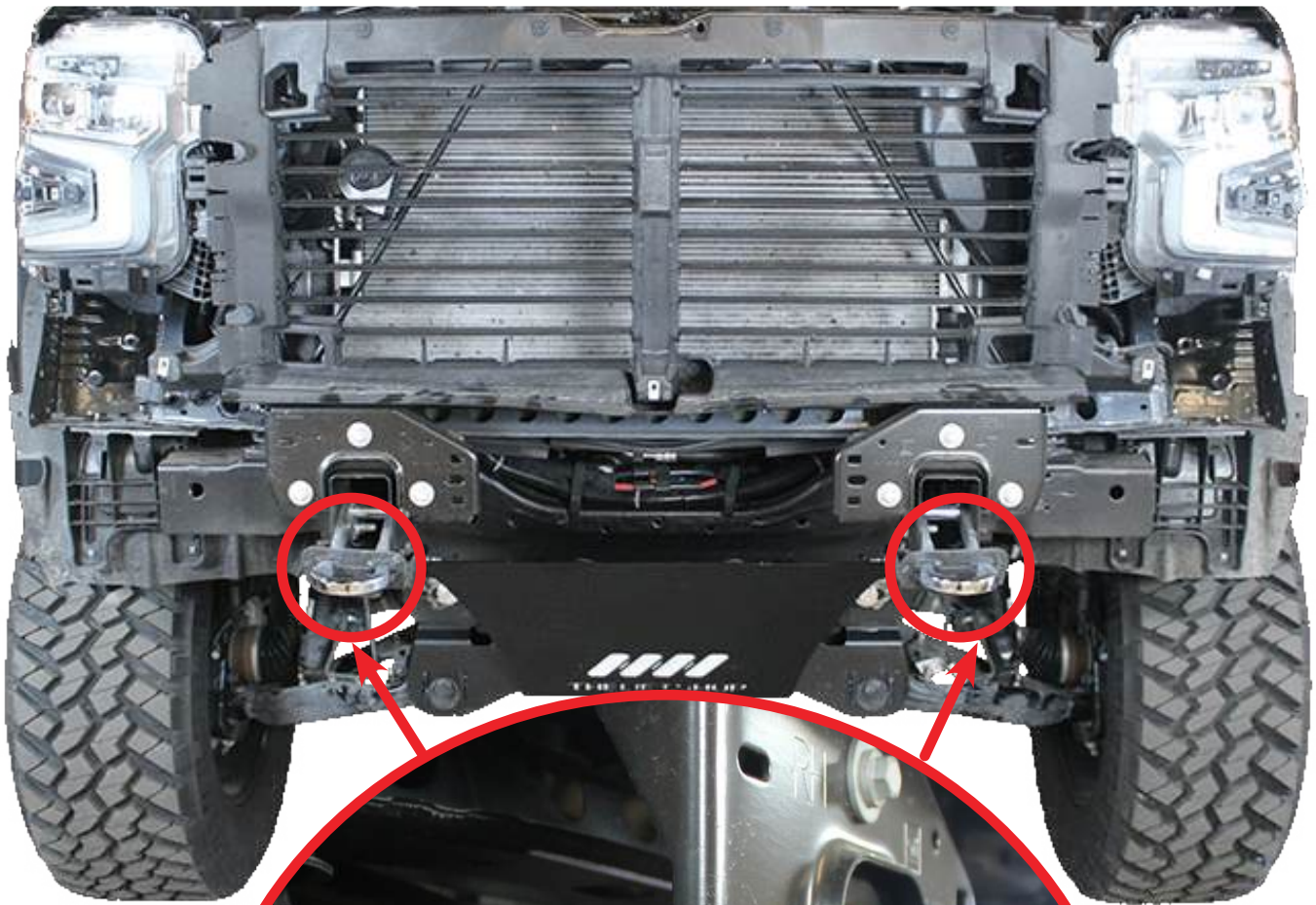

STEALTH FIGHTER FRONT BUMPER 2022-UP/CHEVY 1500

REMOVAL

□ STEP 14

Using a (18mm socket) and a (10mm socket) remove the 4x bolts shown below.

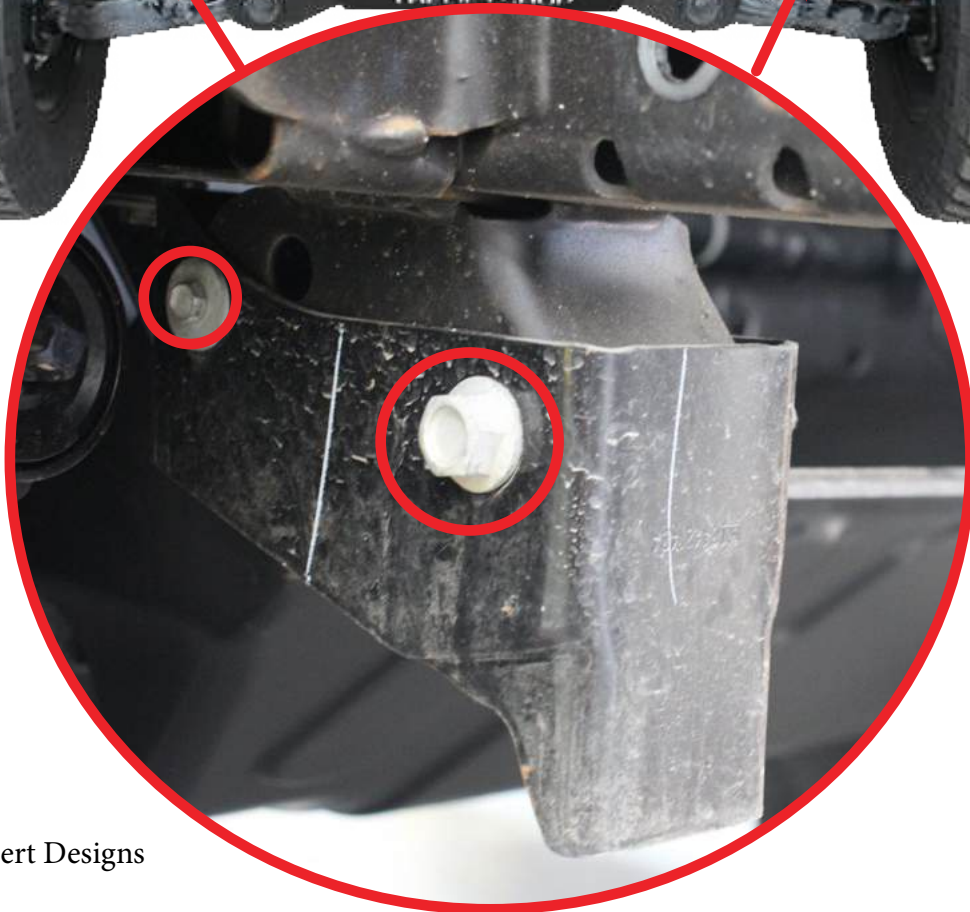
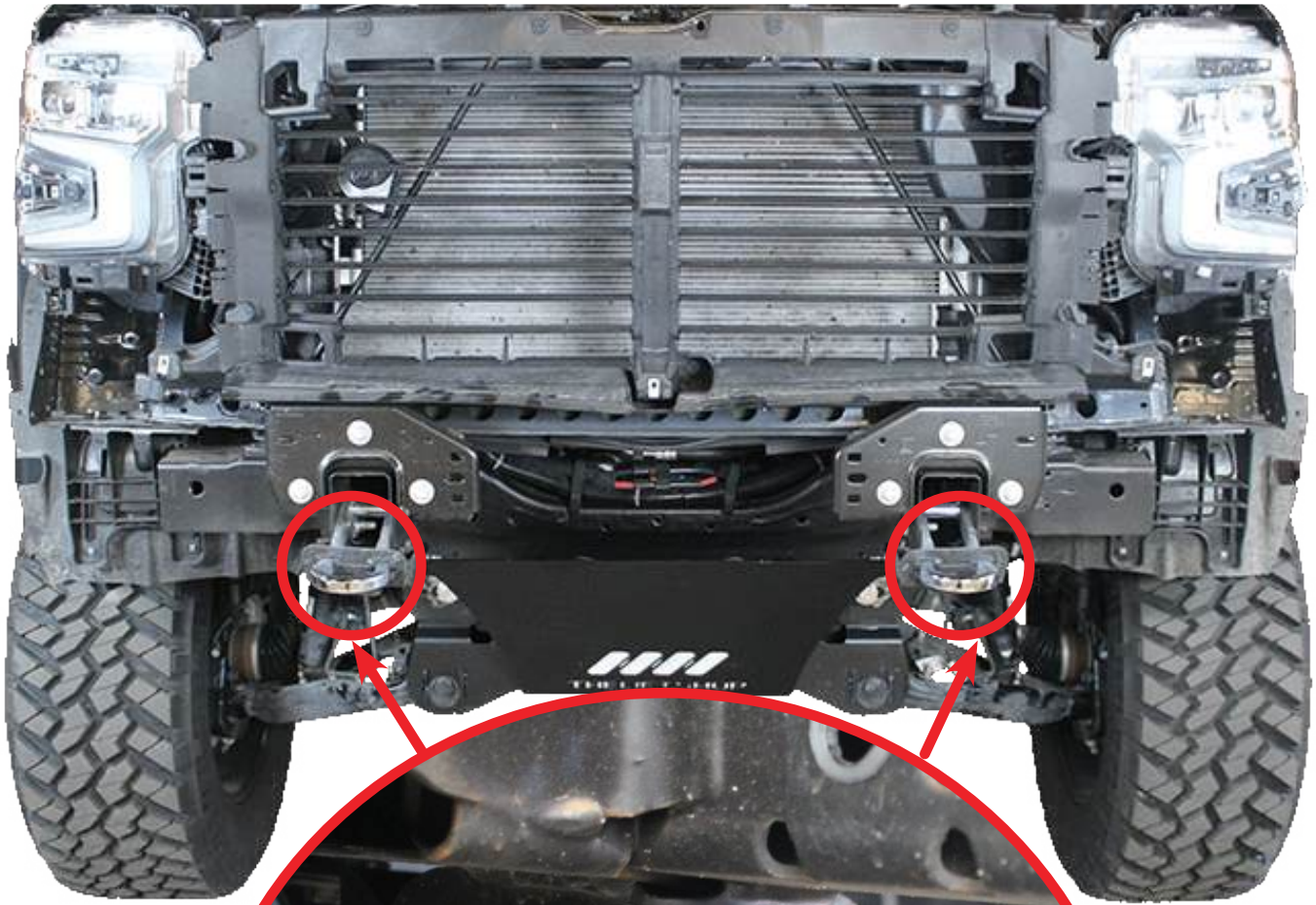

STEALTH FIGHTER FRONT BUMPER 2022-UP/CHEVY 1500

REMOVAL

□ STEP 15

Using a (15mm socket), remove the 6x bumper mounting bracket bolts. (Re-install the grill and valence by repeating steps 1-8)

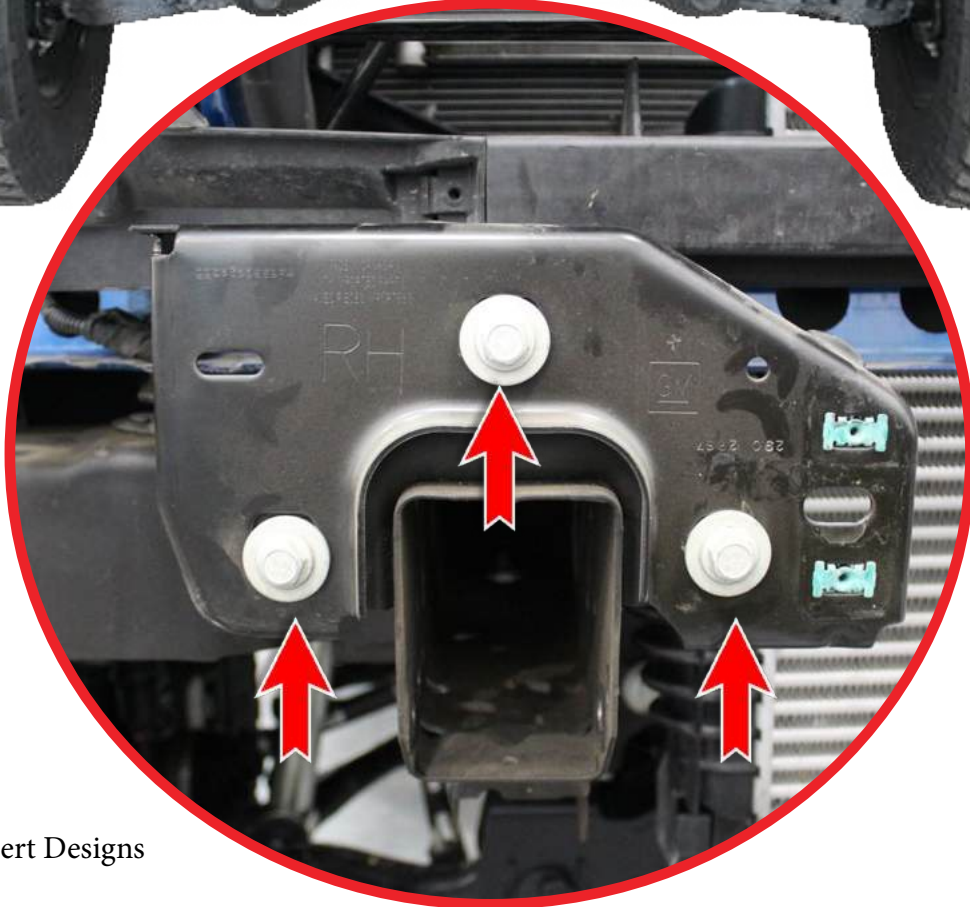
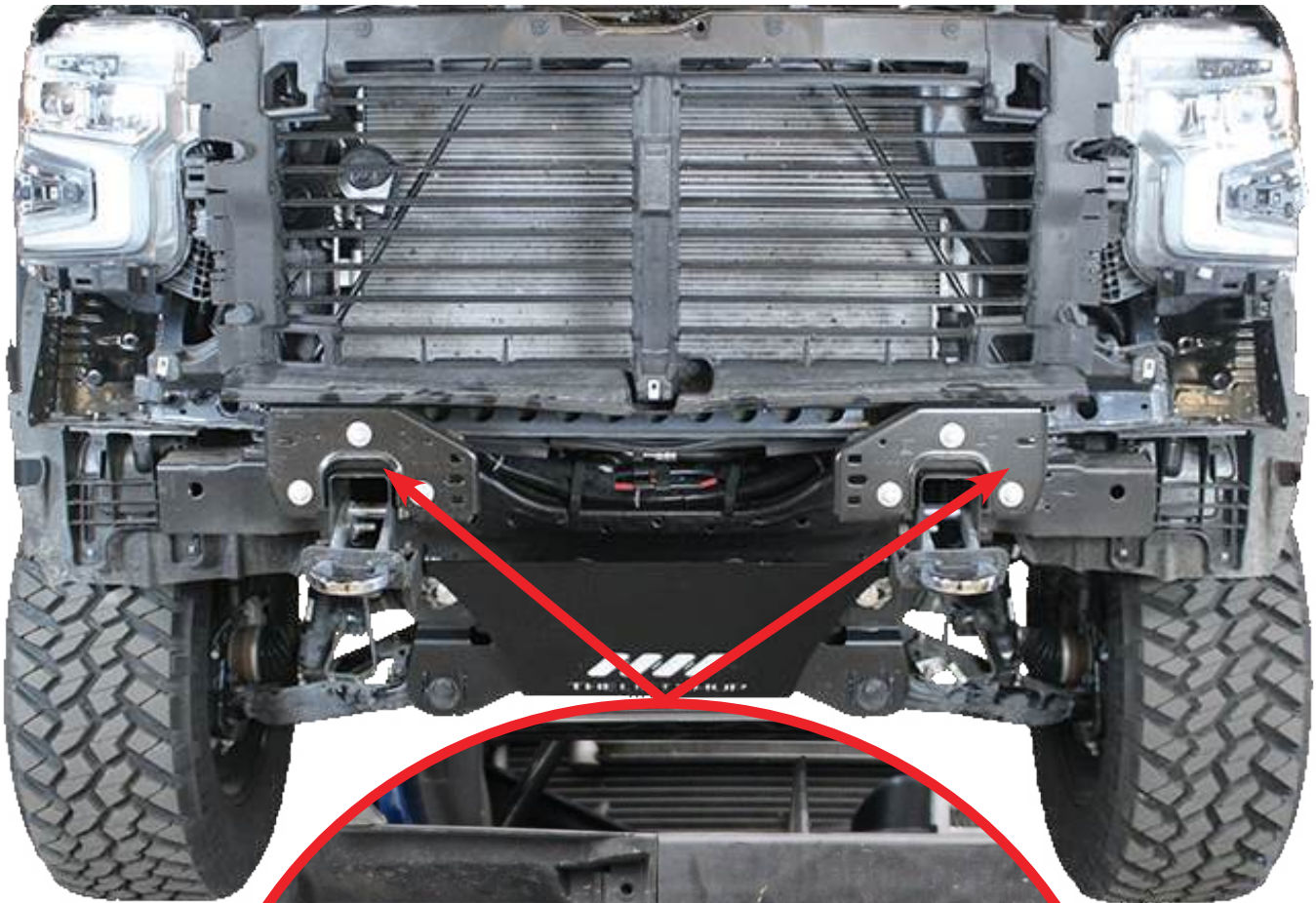

STEALTH FIGHTER FRONT BUMPER 2022-UP/CHEVY 1500

REMOVAL

□ STEP 16

Unplug the fog lights as shown below.

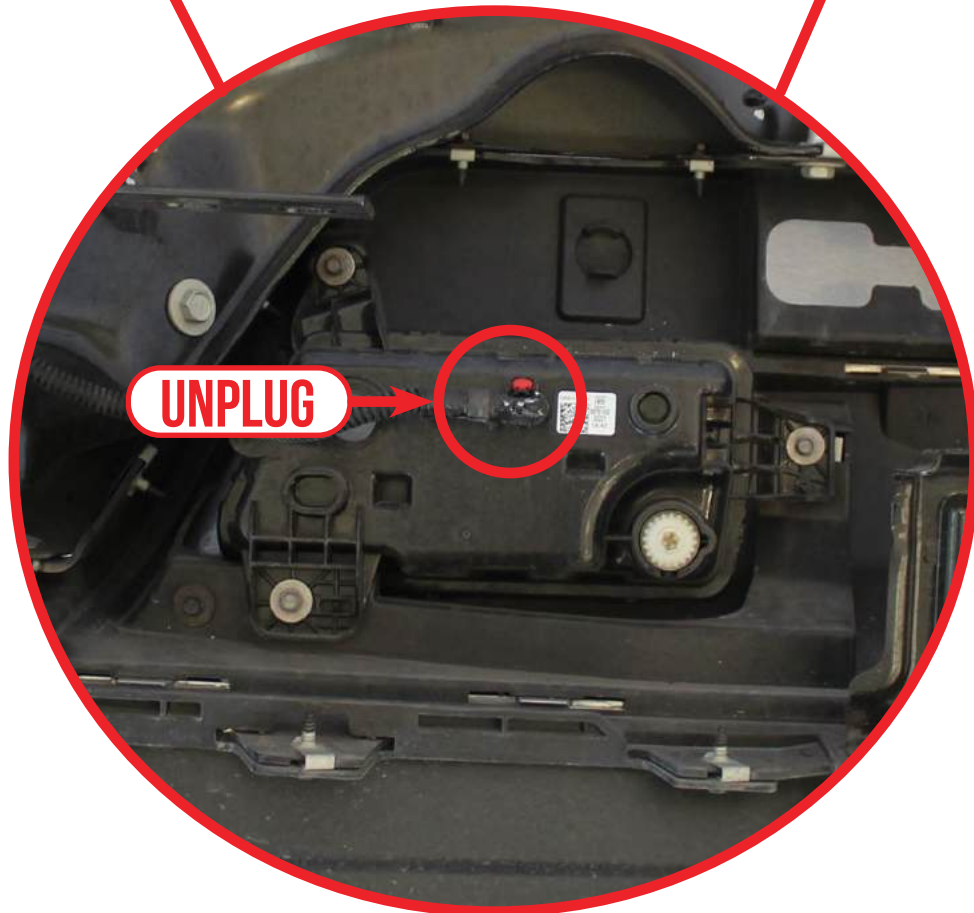

STEALTH FIGHTER FRONT BUMPER 2022-UP/CHEVY 1500

REMOVAL

□ STEP 17

Using a (13mm socket), remove the inner mounting structure of the bumper. Next using a (15mm socket) remove the support bar.

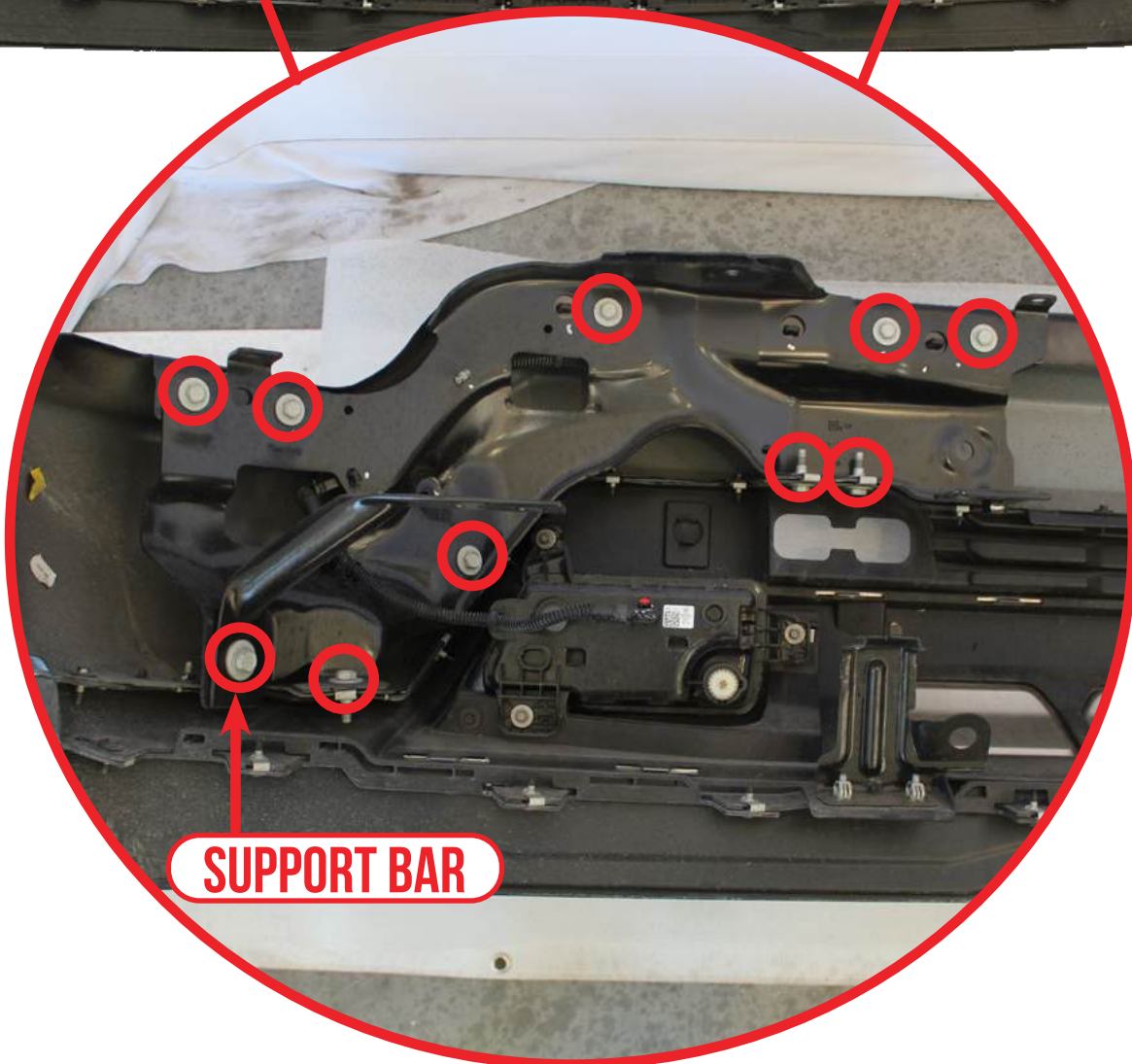

STEALTH FIGHTER FRONT BUMPER 2022-UP/CHEVY 1500

REMOVAL

□ STEP 18

Remove the parking sensors from the bezels by spreading the tabs and pulling out. ****CAUTION: Sensor bezels are fragile****

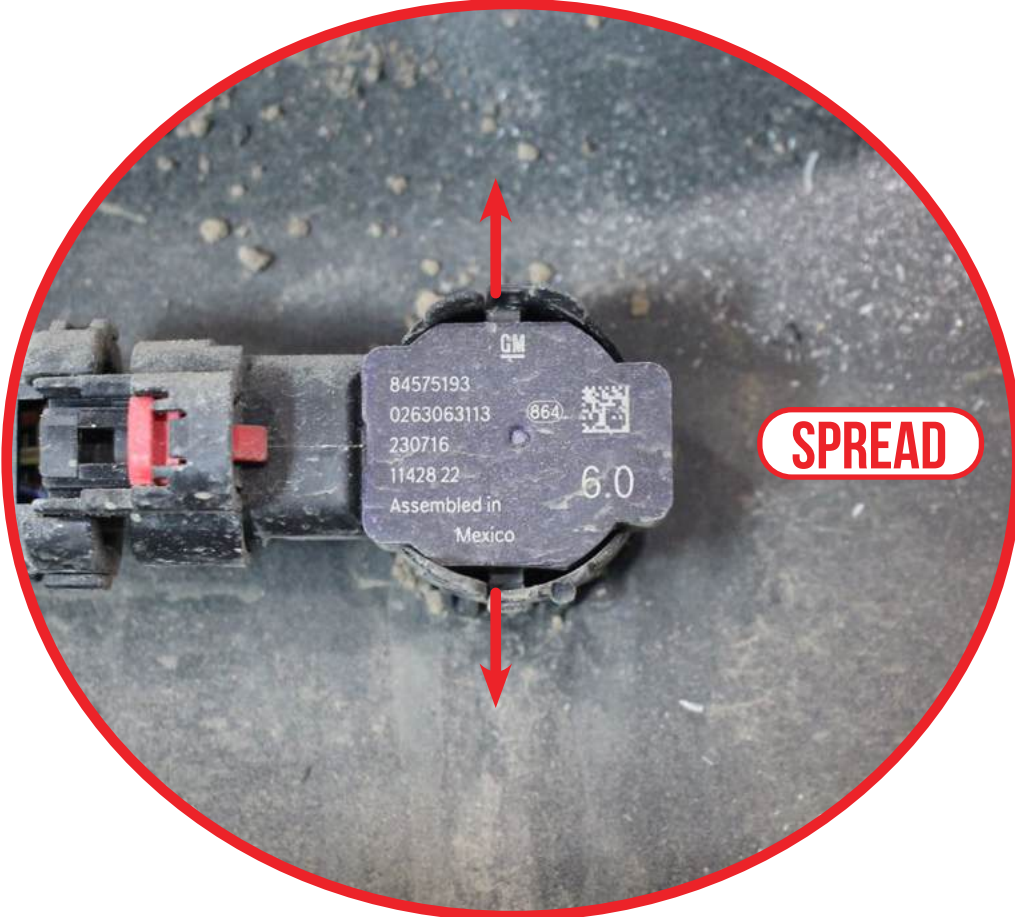

STEALTH FIGHTER FRONT BUMPER 2022-UP/CHEVY 1500

REMOVAL

□ STEP 19

Remove the sensor bezels by pushing the tabs in and sliding out of the bumper. **Remember orientations and positions of bezels**

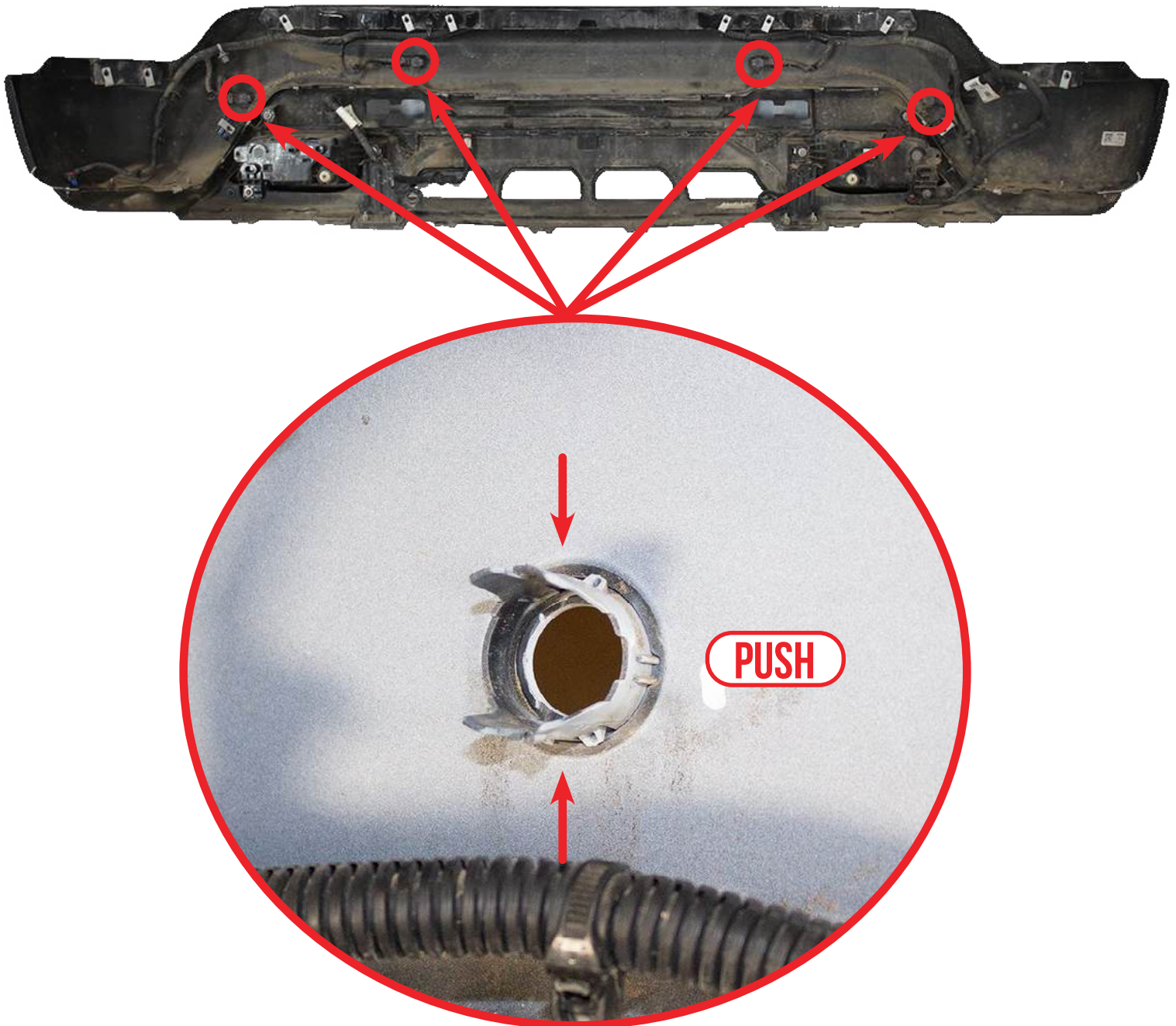

STEALTH FIGHTER FRONT BUMPER 2022-UP/CHEVY 1500

INSTALL

□ STEP 20

Using a (9/16 wrench), install the light mount tabs with the provided **(D, C1, C2)** 3/8" hardware in the slots shown below in **figure 1**.

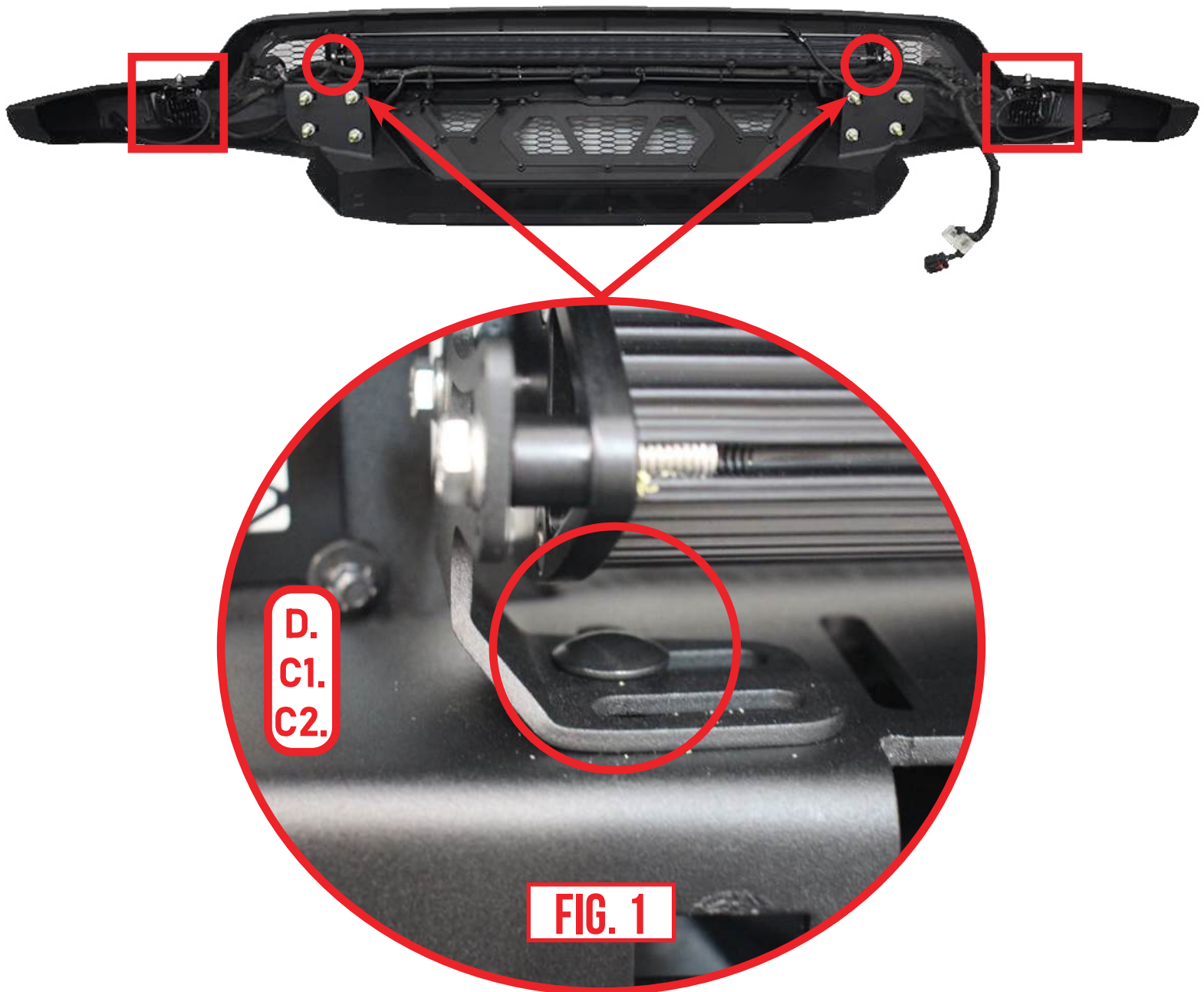

STEALTH FIGHTER FRONT BUMPER 2022-UP/CHEVY 1500

INSTALL

□ STEP 21

Route the wire harness behind the light and zip tie. Next, route the parking sensors as shown below.

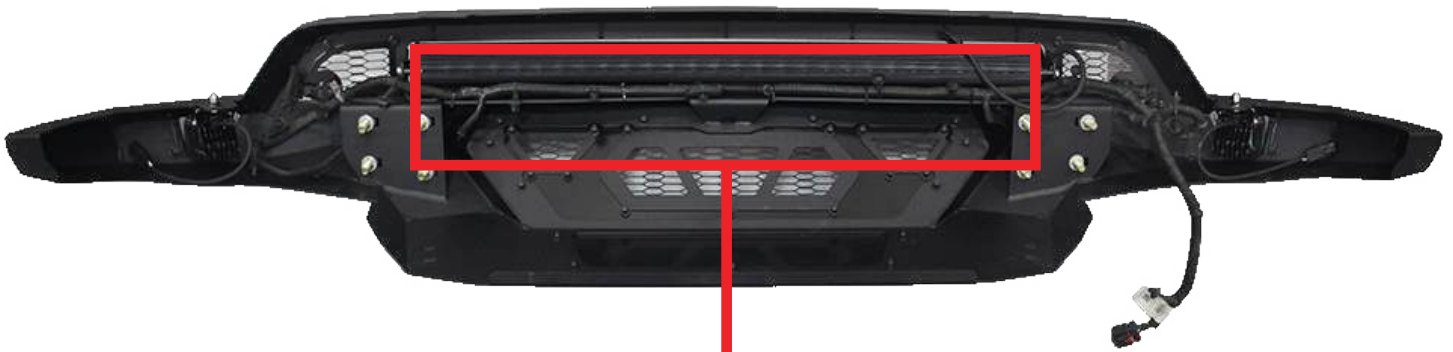

STEALTH FIGHTER FRONT BUMPER 2022-UP/CHEVY 1500

INSTALL

□ STEP 22

Install the sensor bezels removed from **step 18 & 19**. Refer to next page for reference.



STEALTH FIGHTER FRONT BUMPER 2022-UP/CHEVY 1500

INSTALL

□ STEP 23

Passenger outer sensor orientation



STEALTH FIGHTER FRONT BUMPER 2022-UP/CHEVY 1500

INSTALL

□ STEP 24

Driver outer sensor orientation



STEALTH FIGHTER FRONT BUMPER 2022-UP/CHEVY 1500

INSTALL

□ STEP 25

Driver inner sensor orientation. Inner bezels will be swapped. Passenger to driver, and driver to passenger.



STEALTH FIGHTER FRONT BUMPER 2022-UP/CHEVY 1500

INSTALL

□ STEP 26

Passenger inner sensor orientation. Inner bezels will be swapped. Passenger to driver, and driver to passenger.



STEALTH FIGHTER FRONT BUMPER 2022-UP/CHEVY 1500

INSTALL

□ STEP 27

Install the provided (F, F1) 1/2" hardware to the bumper as shown below.

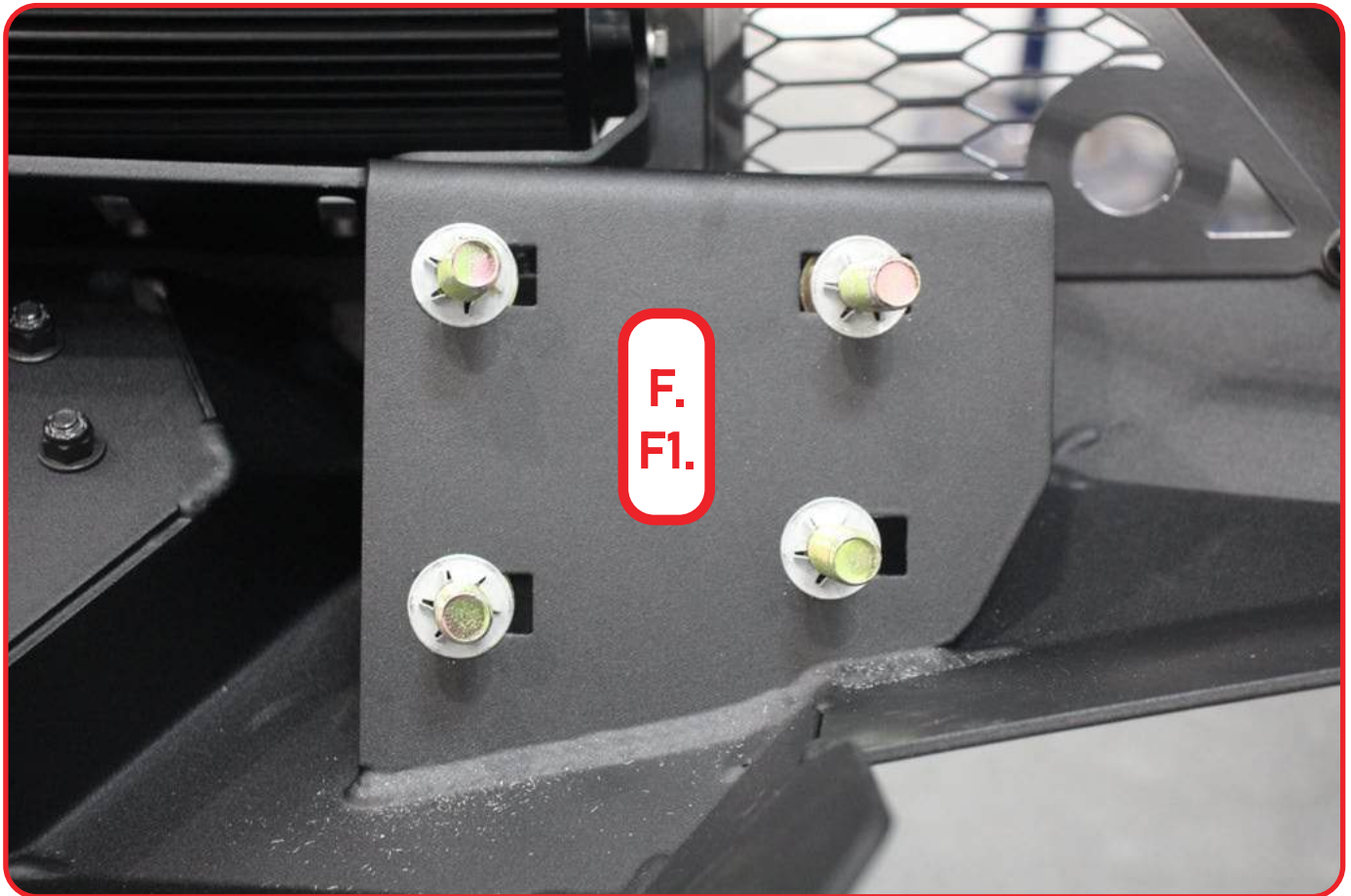

STEALTH FIGHTER FRONT BUMPER 2022-UP/CHEVY 1500

INSTALL

□ STEP 28

Install the mounting brackets to the frame horns with the provided **(E, E1, E2)** 1/2" hardware using a (3/4 socket) and a (3/4 wrench).



STEALTH FIGHTER FRONT BUMPER 2022-UP/CHEVY 1500

INSTALL

□ STEP 29

Install the provided (A, A1, A2) 5/16" hardware to the mounts using a (1/2" socket) and a (1/2" wrench).

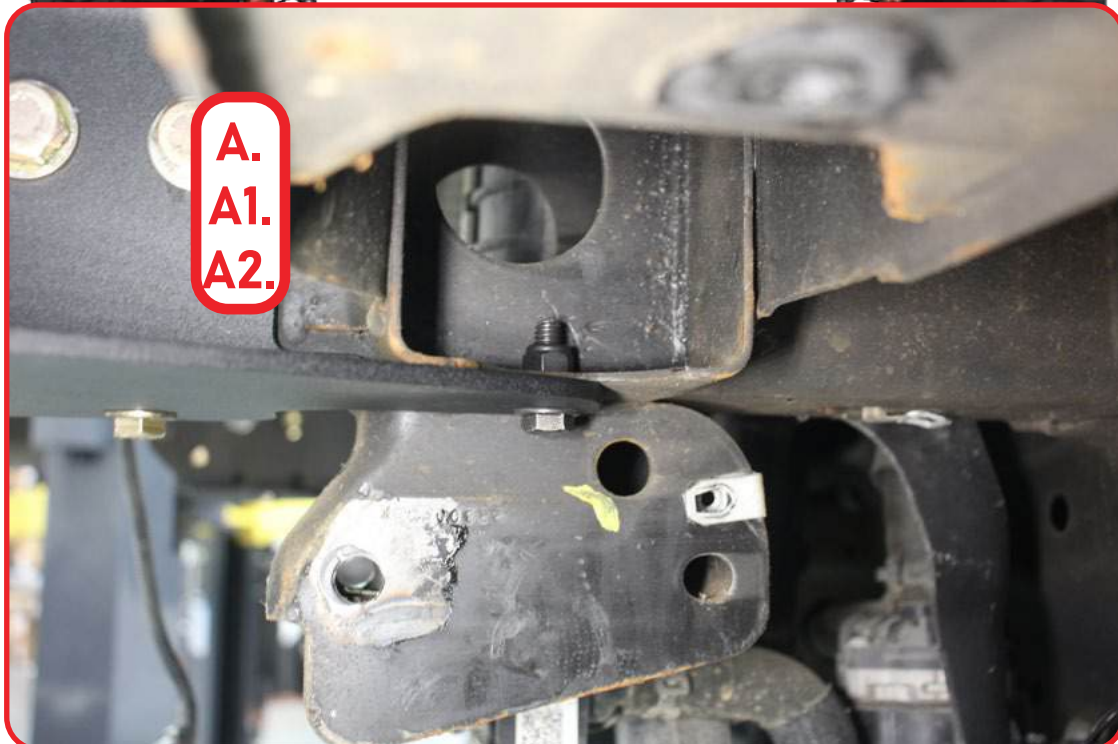

STEALTH FIGHTER FRONT BUMPER 2022-UP/CHEVY 1500

INSTALL

□ STEP 30

Install the provided **(B, B1, C1)** 3/8" hardware using a (9/16 socket) and a (9/16 wrench).



STEALTH FIGHTER FRONT BUMPER 2022-UP/CHEVY 1500

INSTALL

□ STEP 31

Install the provided **(I)** bracket to the outside of the mounting holes from step 14 with the provided **(G, E1, E2)** 1/2" hardware using a (3/4 socket) and a (3/4 wrench).



STEALTH FIGHTER FRONT BUMPER 2022-UP/CHEVY 1500

INSTALL

□ STEP 32

With a helping hand, install the bumper to the mounts with the provided (E1, E2) 1/2" hardware using a (3/4 socket).



STEALTH FIGHTER FRONT BUMPER 2022-UP/CHEVY 1500

INSTALL

□ STEP 33

Install the provided (C, C1, C2) 3/8" hardware through the bottom of the bumper to the bracket installed on step 31 using a (7/32 allen) and a (9/16 wrench).



STEALTH FIGHTER FRONT BUMPER 2022-UP/CHEVY 1500

INSTALL

□ STEP 34

Plug in the wire harness.



STEALTH FIGHTER FRONT BUMPER 2022-UP/CHEVY 1500

INSTALL

□ STEP 35

Trim the inner wheel well using a (razor blade/scissors) as shown below.



STEALTH FIGHTER FRONT BUMPER 2022-UP/CHEVY 1500

FINAL

□ STEP 36

Stand back and enjoy your new ADD Stealth Fighter Front Bumper.

Check and re-tighten, if needed, all mounting bolts after 100 miles and periodically thereafter.



THIS PRODUCT IS PROTECTED BY ONE OR MORE U.S. PATENTS
WWW.ADDICTIVEDESERTDESIGNS.COM/PATENTS

FOR ADDITIONAL SUPPORT OR TECHNICAL QUESTIONS,
PLEASE CALL 480-671-0820 OR
EMAIL INFO@ADDICTIVEDESERTDESIGNS.COM